

HP® COLOR LASERJET CM4540

TONER CARTRIDGE REMANUFACTURING INSTRUCTIONS



HP CM4540 TONER CARTRIDGE

REMANUFACTURING THE HP COLOR LASERJET CM4540 SERIES BLACK & COLOR TONER CARTRIDGES

By Mike Josiah and the Technical Staff at UniNet



The CM4540 series of multi function color laser printers are based on a 42 ppm black and color 600 x 600 DPI engine, 3600 DPI with RET (resolution enhancement technology). The 4540 cartridges are an all in one type cartridge that consists of the toner supply, drum, and waste chamber. Like a few of the other newer high volume HP color laser printers, the cartridges in this series are orientated so that the drum faces up not down when placed in the printer. Because of this machine layout, we will take a moment and run through the printer theory before we get started.

The cartridge is basically a modified HP CP4525 cartridge. In fact, the CE260A works in both series, as does the waste collection bottle. They all have a toner seal and a snap-on drum cover across the bottom to protect the drum.

These printers have a separate waste bottle to collect the waste toner from the ITB belt and use chips that's need to be replaced each cycle. The color cartridges and the high yield Black have a larger shoulder on the toner hopper.

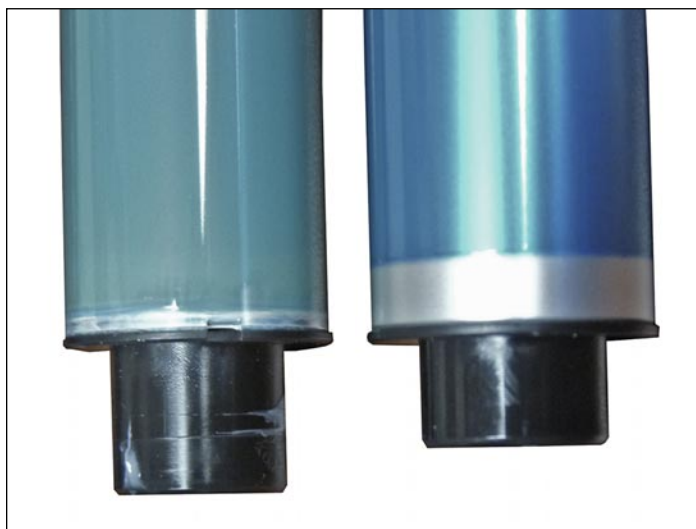

The major difference between the CP4525 cartridges and the high yield cartridges in this series is the plastic housing (shoulder) and the drum. The contact hub of the new CM4540 drum is larger with the inner hub that houses the drum axle pin stronger and more recessed.

The older CP4525 drum hub design had a tendency to allow the drum axle pin to move out of the hub slightly when large runs were printing causing print defects. This new design seems to be keeping the drum axle pin firmly in place.

PRINTERS BASED ON THE CM4540 ENGINE

- HP Color LaserJet Enterprise CM4540 MFP
- HP Color LaserJet Enterprise CM4540f MFP
- HP Color LaserJet Enterprise CM4540fskm MFP

CARTRIDGES USED IN THESE MACHINES

CE260A (Black)	8,500 pages	\$159.99 list*
CE264X (Black high yield)	17,000pages	\$280.90 list*
CF031A (Cyan)	12,500 pages	\$350.86 list*
CF033A (Magenta)	12,500 pages	\$350.86 list*
CF032A (Yellow)	12,500 pages	\$350.86 list*
CE265A (Toner collection unit)		\$18.00 list*

*Pricing (in U.S. American Dollars) current as of September 2012.

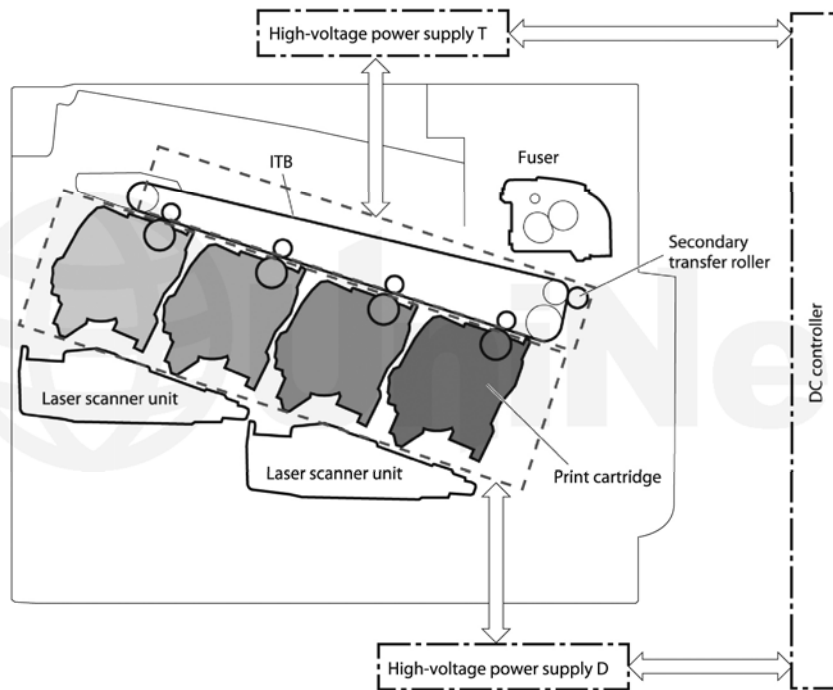

HP-CP4520 COLOR PRINTING THEORY

The color toner cartridge printing process happens in a series of stages or steps. For the purpose of this article, we will call them stages. Shown above is a basic layout of the cartridges and how they relate to one another and the printer. Note that while this is still a single-pass system, the layout is completely different from any previous Canon/HP machines. The laser units are on the bottom, the cartridges are at an angle, and the ITB is on top.

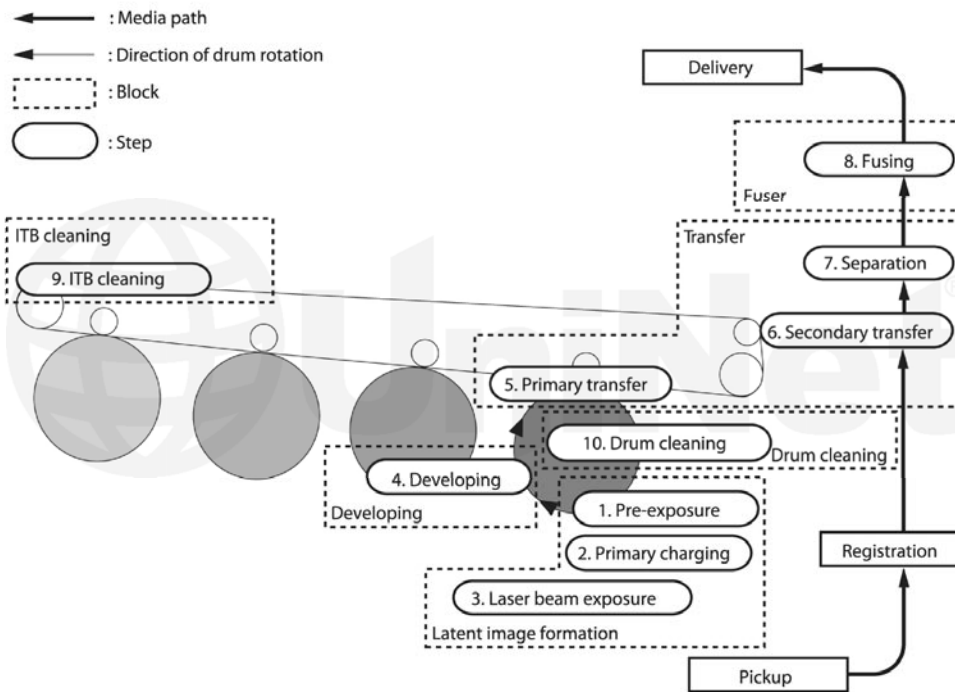

Shown is the complete image formation process.

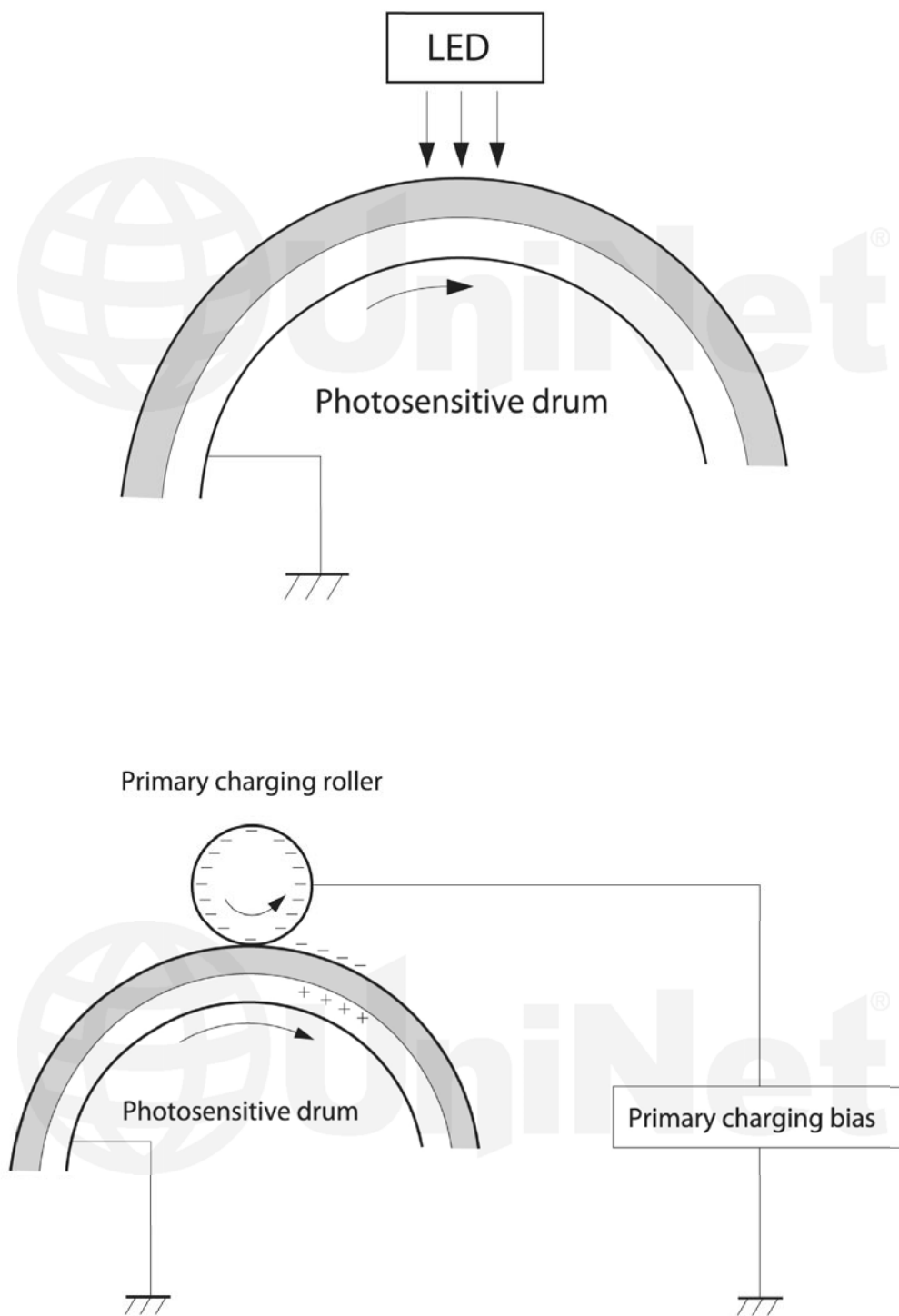

In the **first** stage, light from the pre-exposure LED strikes the drum to remove any residual charges from the drum's surface. Then, the Primary Charge Roller (PCR) places a uniform negative DC voltage on the OPC drum surface. The amount of the negative DC voltage placed on the drum is controlled by the printer's intensity setting.

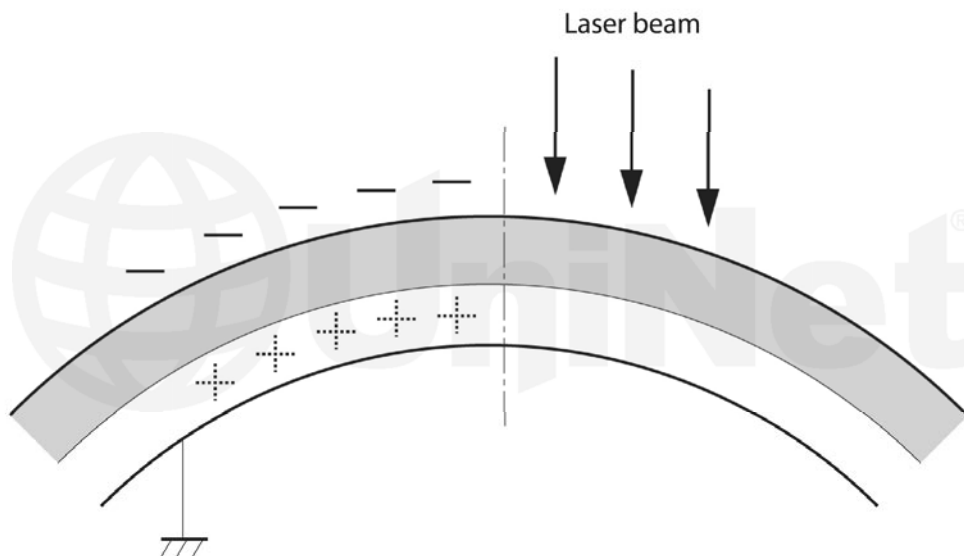

In the **second** stage, a dual laser beam is fired onto a rotating mirror (called the scanner). As the mirror rotates, the beams are reflected into a set of focusing lenses. The beams then strike the drums surface, reducing the negative charge and leaving a latent electrostatic image on the drum. The areas where the lasers did not strike the drum will retain the higher negative charge. While some previous printers had one scanner unit with four lasers, these machines have two separate laser/scanner units: one for Black and Cyan, and one for Magenta and Yellow. Dual lasers are used to allow faster print speeds.

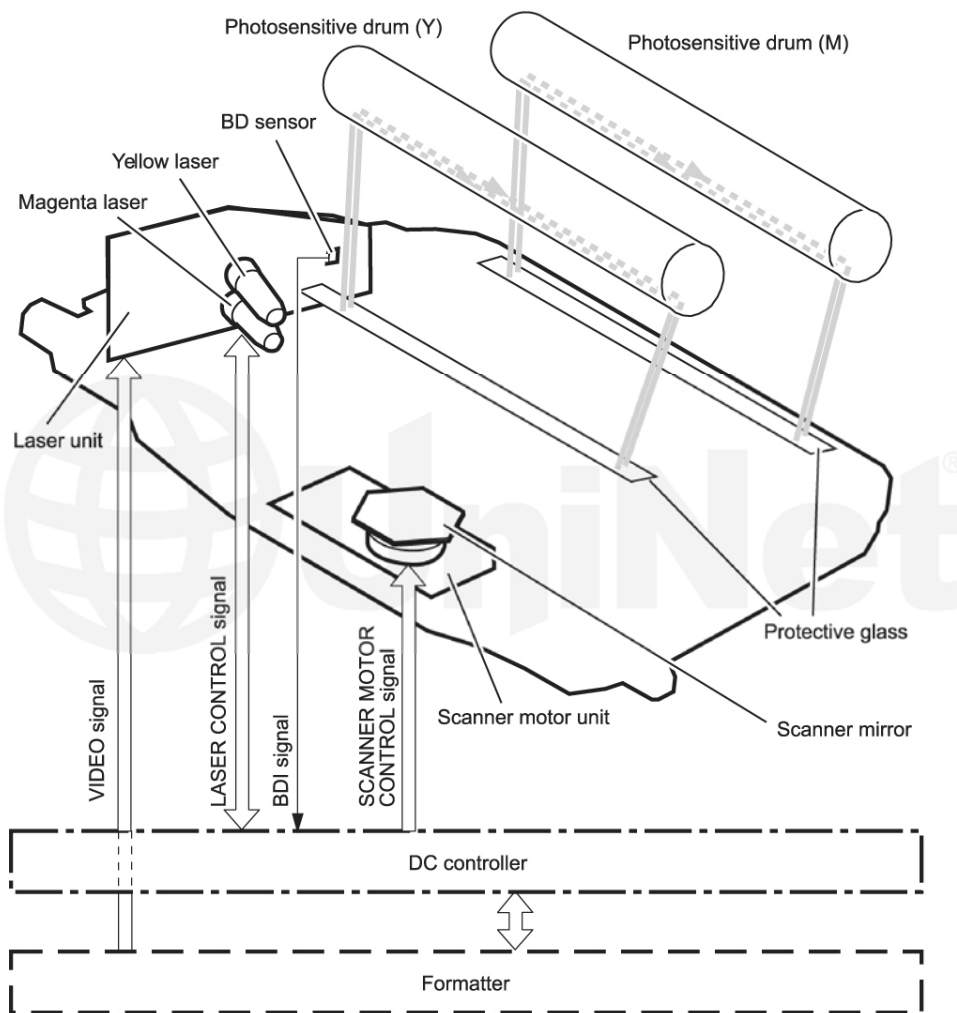

The **third** or developing stage is where the toner is developed on the drum by the developing section (or supply chamber), which contains the toner particles. The development stage is actually made up of two steps: toner charging and the actual development. In the toner charging stage, the toner stirring blade turns inside the hopper. As it turns, friction causes a negative potential to develop on the toner. In addition, a foam feed roller brings the toner to the developer roller and also places a negative charge on the toner. These two charges help ensure a uniform charge on the toner.

Once the toner is properly charged, the toner will coat the developer roller. The toner is also held onto and attracted to the developer roller by another negative DC bias voltage. This voltage is controlled by the printer's intensity setting and causes either more or less toner to be attracted by the developer roller. This in turn will either increase or decrease the print density. The amount of toner on the developer roller is controlled by the doctor blade, which uses pressure to keep the amount of toner on the roller constant.

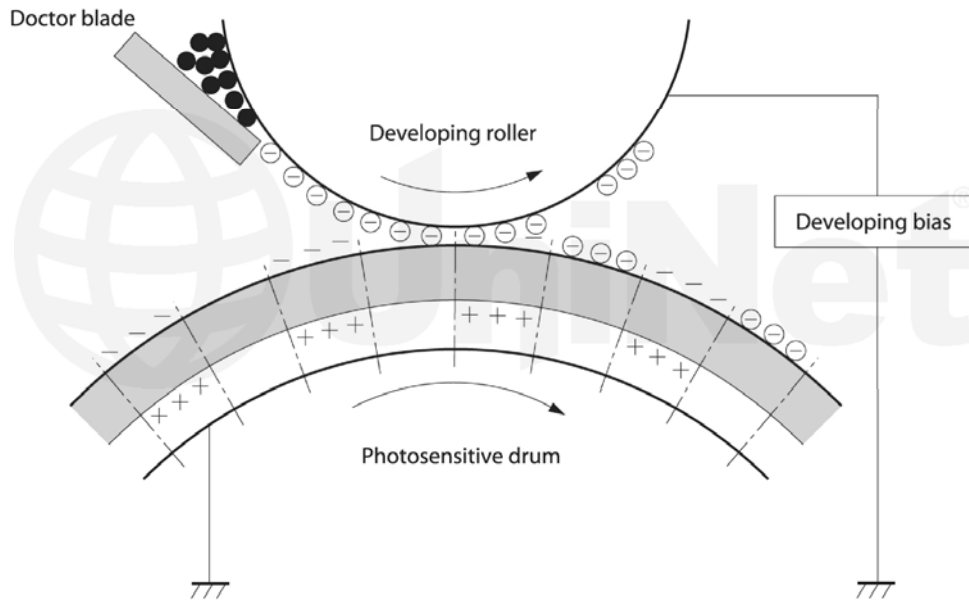

As the laser-exposed areas of the OPC drum approach the developer roller, the toner particles are attracted to the drum's surface due to the opposite voltage potentials of the toner, and laser exposed areas of the OPC drum.

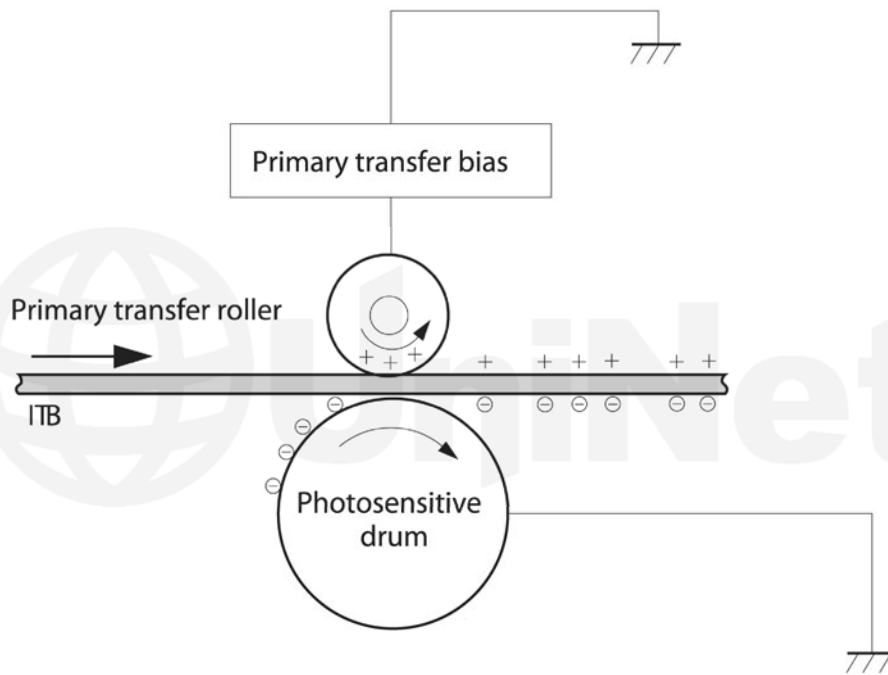

The **fourth** stage is the transfer stage. This is where there are some large differences from monochrome printers and also from other color lasers. In the primary transfer stage the transfer roller which is located directly opposite each OPC drum, places a positive DC bias charge on the back of the ITB or Image Transfer Belt. Each toner cartridge has a separate transfer charge roller. The image is transferred from the drum directly to the ITB. This process is repeated for each color cartridge in the following order: Yellow, Magenta, Cyan, and Black. At the same time, the paper is moving between the secondary transfer roller and the ITB. As the ITB passes the secondary transfer roller, the positive charge is picked up, and draws the negatively charged toner off the belt and onto the paper. Note that this entire process is upside down from most previous HP engines. The ITB and transfer rollers are on top of the OPC drum, not underneath it..

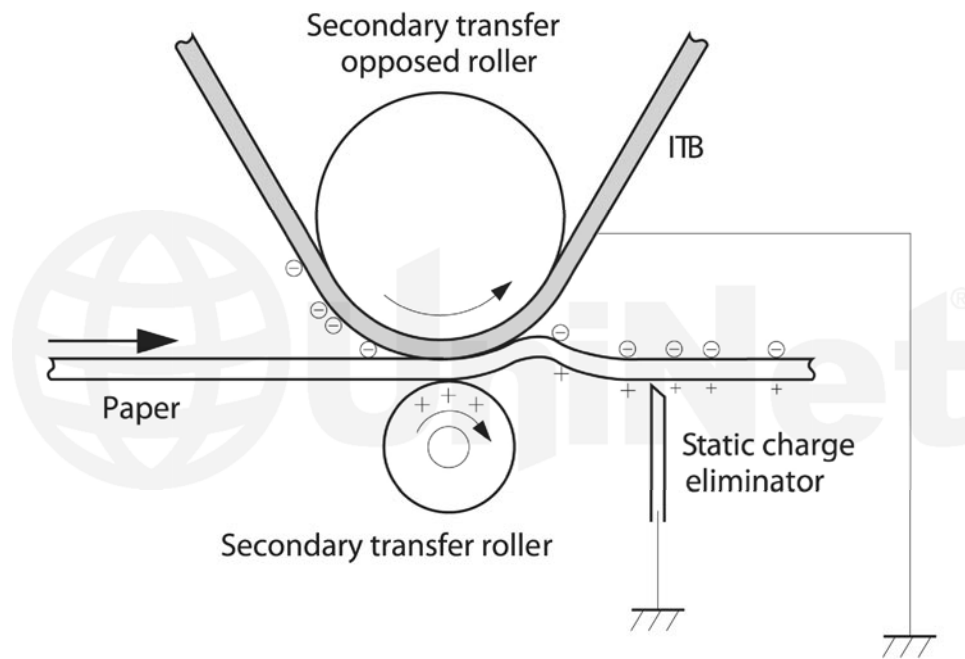
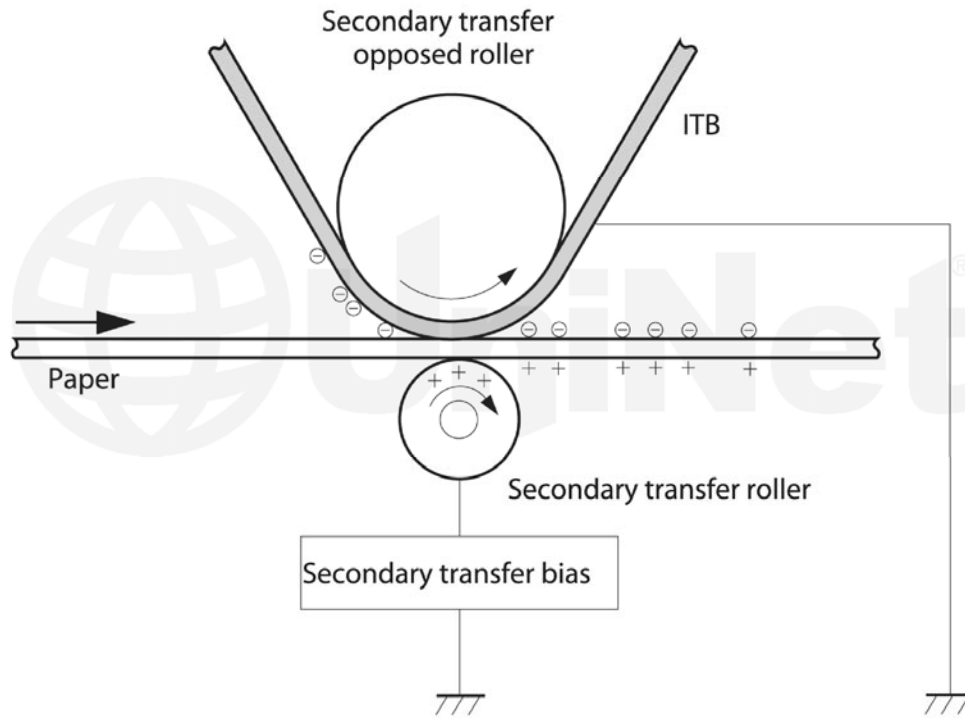

The paper separates from the ITB belt as the belt turns back down to start the process again. The static charge on the back of the paper is decreased with static charge eliminator. This helps stabilize the paper feed, and also prevents toner flares (spots) under low temperature and low humidity conditions.

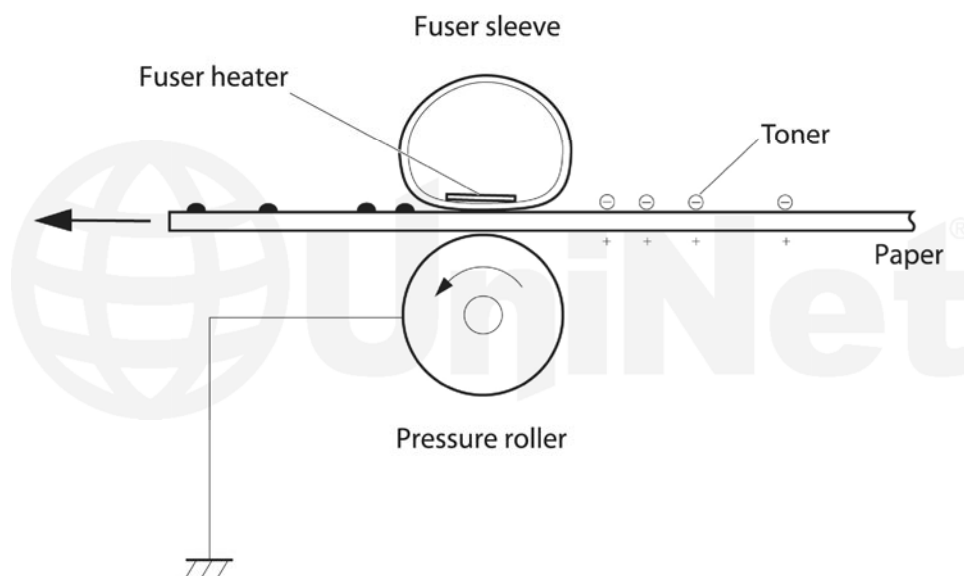

In the **fifth** stage, the image is then fused onto the paper by the fuser assembly. The fuser assembly is comprised of the upper heating assembly and lower pressure roller. The lower pressure roller presses the page up into the upper heating assembly which then melts the toner into the paper. This heating assembly consists of a flexible sleeve with a ceramic heating coil inside. This type of fuser affords “instant on” fusing with little to no wait time, and low power consumption.

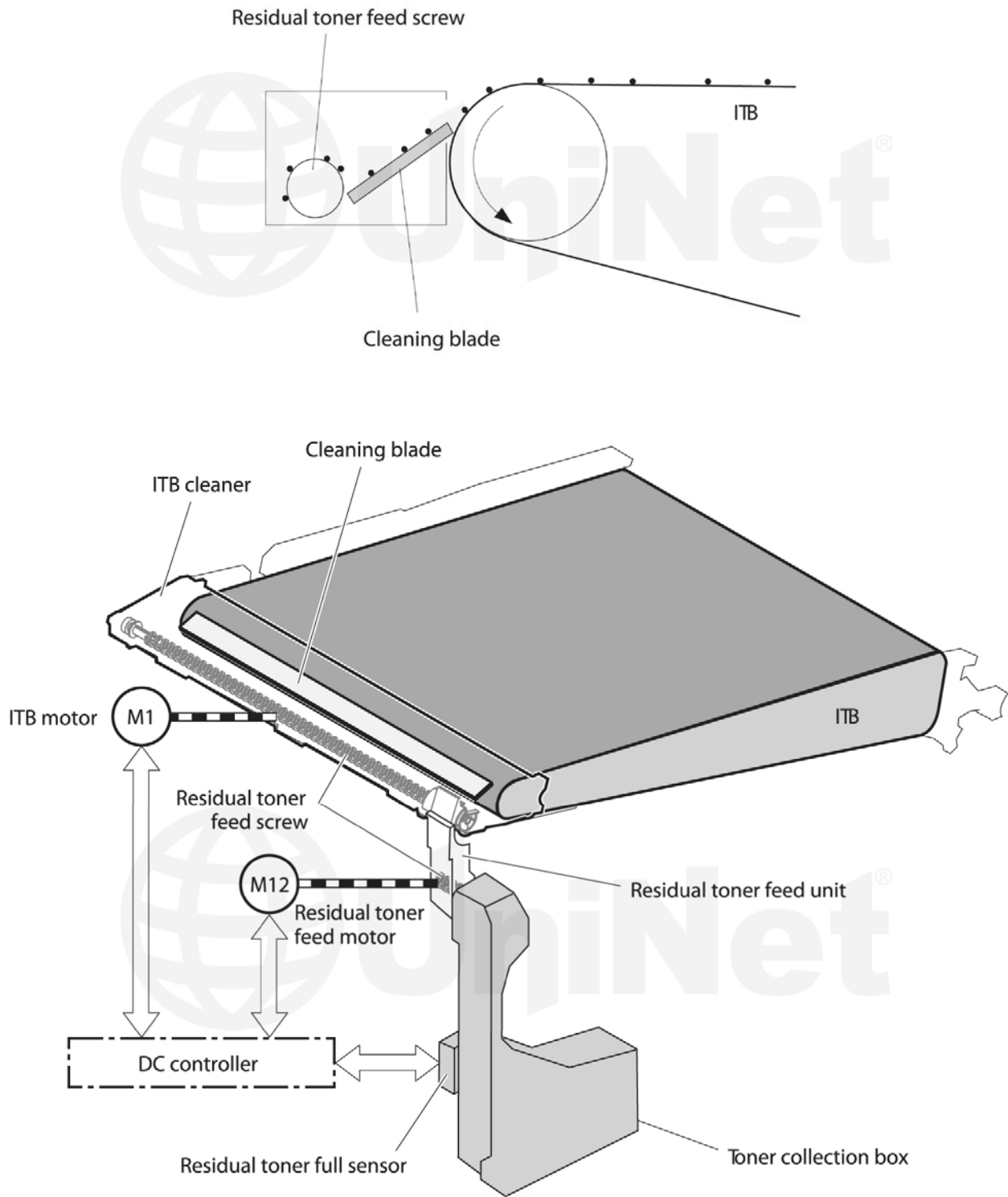

ITB CLEANING

The ITB is cleaned by the ITB cleaning blade.

The ITB wiper blade scrapes off the residual toner and an auger moves the toner to the toner collection box.

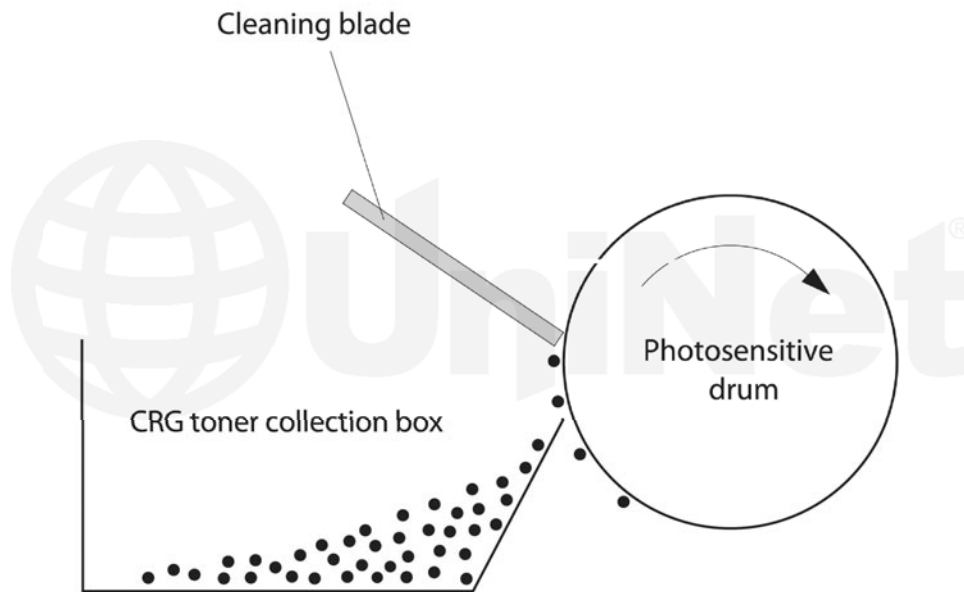

OPC DRUM CLEANING

The drum is cleaned after the image is transferred to the paper by the wiper blade. This part is fairly standard: the wiper blade scrapes the toner off the drum, and the recovery blade guides it into the waste chamber.

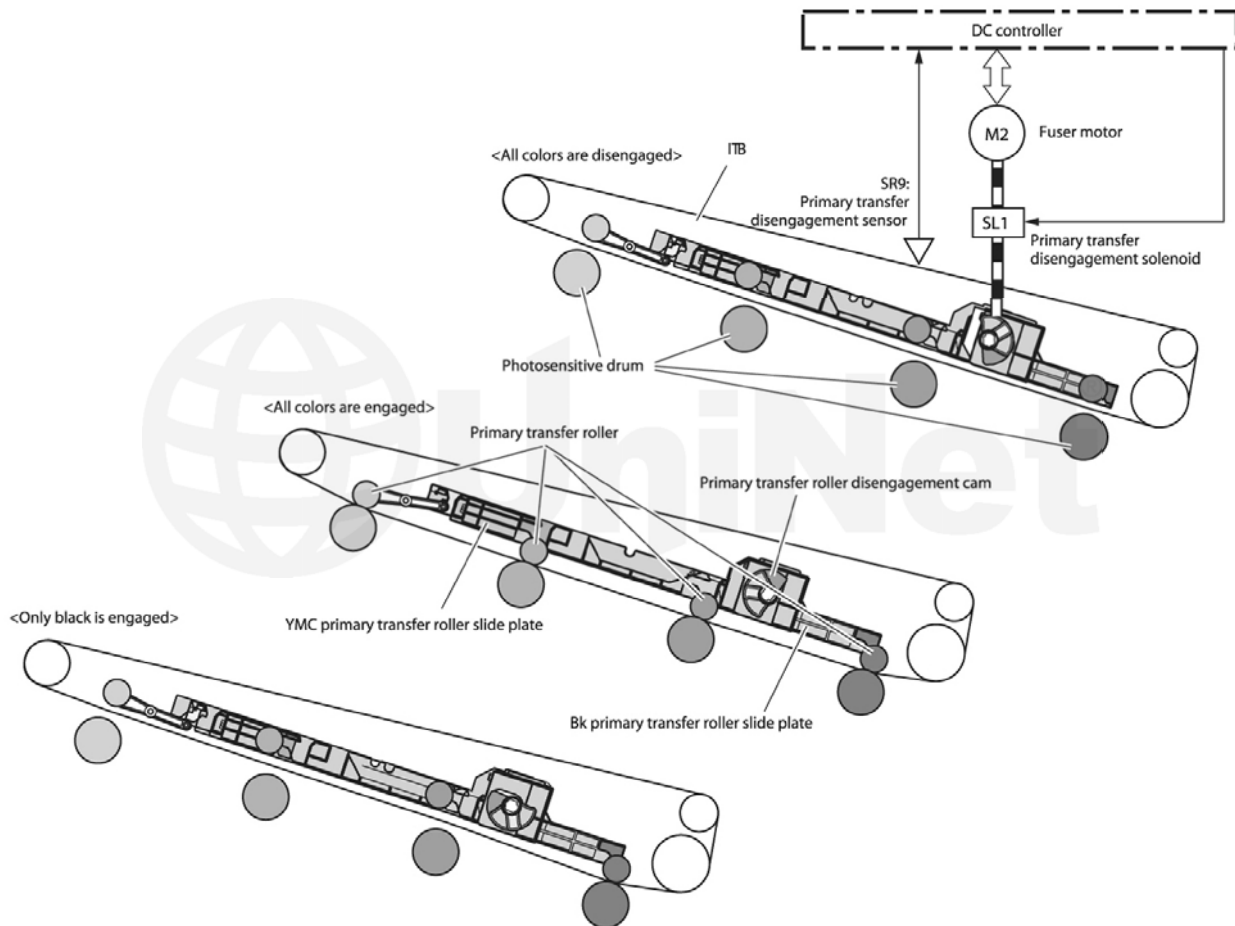
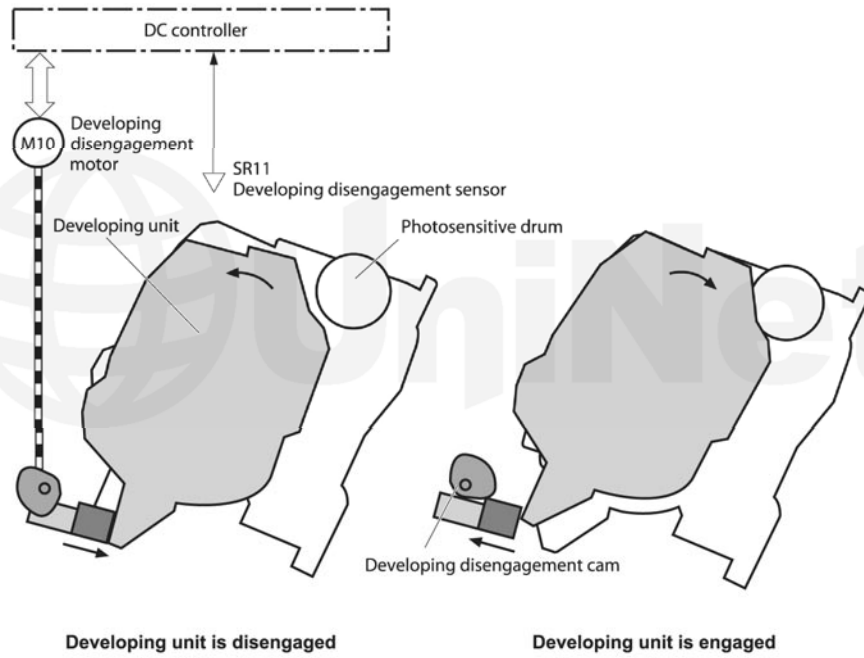

These printers can print in full color or in black-only modes. To print in the black-only mode, the printer disengages the developer rollers in the cyan, magenta, and yellow cartridges. This process also takes place with the primary transfer rollers and the ITB belt.

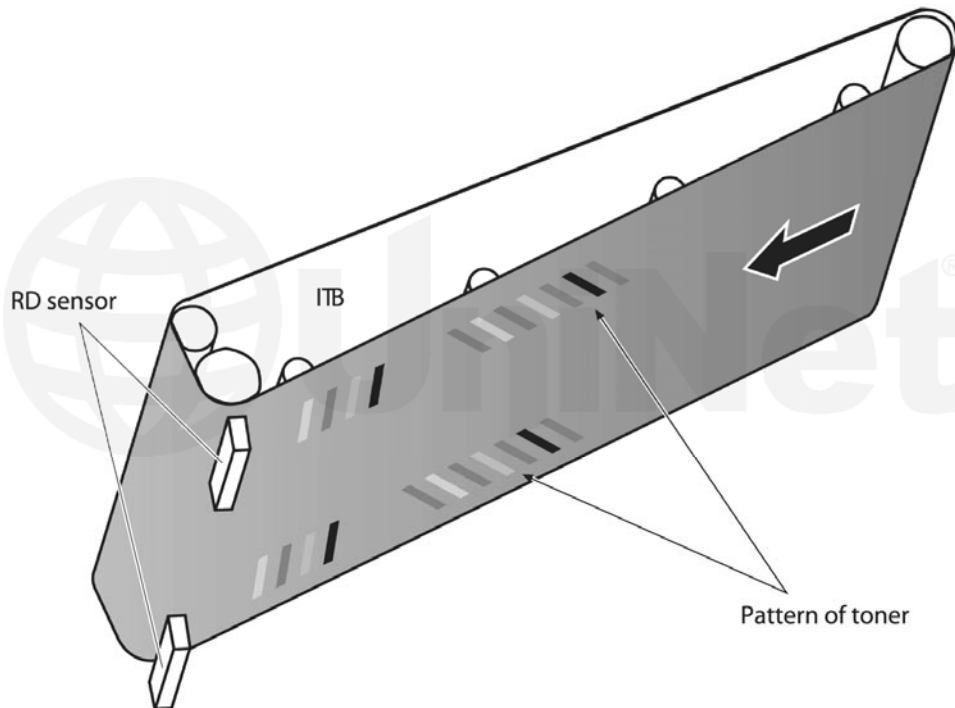

PRINTER CALIBRATION

At the start of all this is the cartridge detection process, toner level detection, and then the calibration cycle. The printer will calibrate whenever the printer is turned on (within 15 minutes), when a new toner cartridge is installed and after 48 hours of run time. Calibration consists of a solid block and halftone of each color being printed to the ITB. As the printed areas get to the top of the belt, a sensor will detect them, measure the density, and adjust the printer accordingly. All of the calibration time settings are user controllable.

Taking test prints, cartridge troubleshooting, as well as minor printer troubleshooting will be covered at the end of this article.

REQUIRED TOOLS

1. Toner approved vacuum
2. A small screwdriver (common style)
3. A Phillips head screwdriver
4. Needle nose pliers
5. Spring hook

SUPPLIES REQUIRED

1. Toner for use in the HP CM4540
2. New replacement chip
3. New dedicated long life drum for use in the CM4540
4. New wiper blade
5. New toner feed roller (optional)
6. New PCR (optional)
7. New doctor blade (optional)
8. Drum cover
9. Lint-free cloths
10. Conductive grease



1. The pins in these cartridges are stepped. In other words the outside is thicker than the inside. To remove the pins, you must carefully shave the plastic away from the pins. The procedure is described in the following steps:

First, remove the spring from the label side of the cartridge.

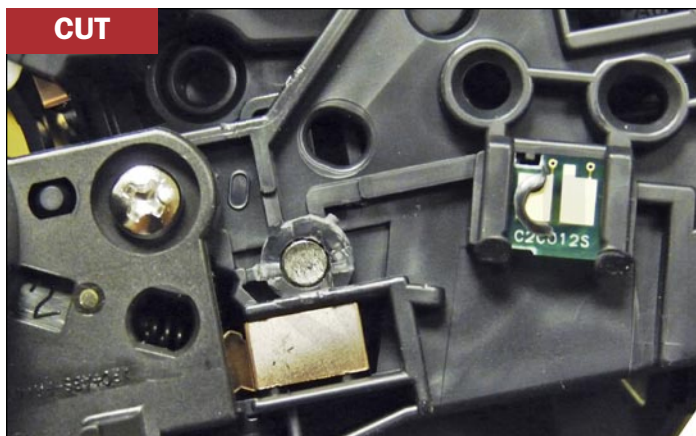
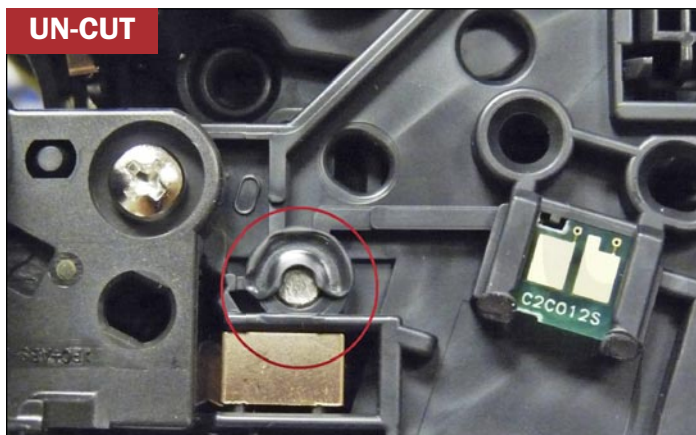

2. With a razor knife, carefully shave the plastic from the heads of the hinge pins on both sides of the cartridge.



3. On the label side only, drill a shallow hole on each side of the pin as shown.

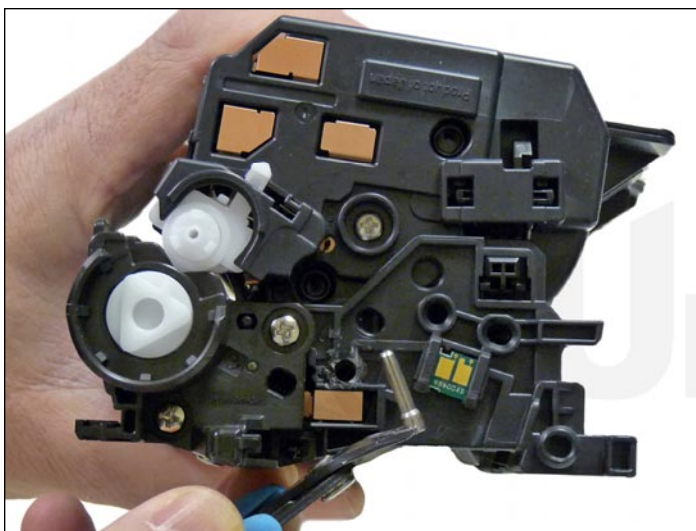

4. Remove the pins with flush cutting wire cutters.

The smaller pin fits on the contact side of the cartridge, the long pin on the label or gear side.

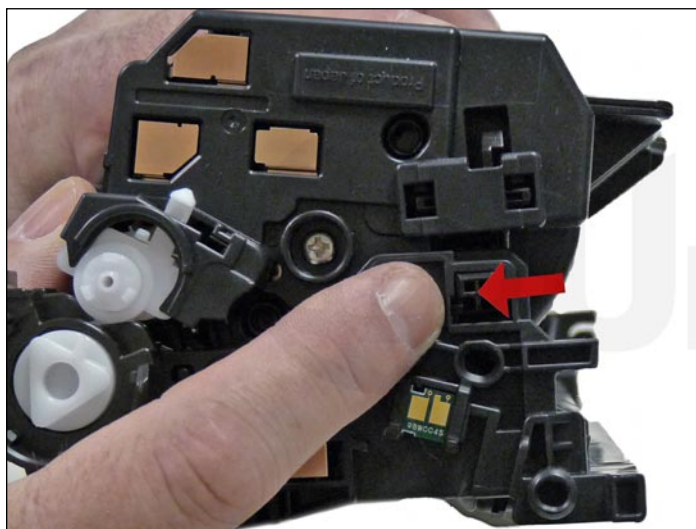

5. On the gear side, press in on the plastic locking mechanism.



6. On the opposite side, lift up on the black lever.

Lift the two halves apart.

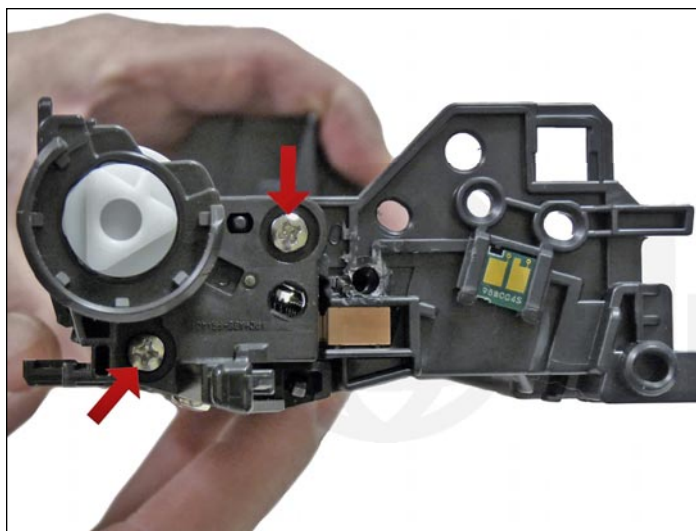

7. On the waste chamber, remove the two screws from the drum gear end cap.

Press in on the tab as shown and remove the end cap.

There is no need to remove the opposite side end cap.

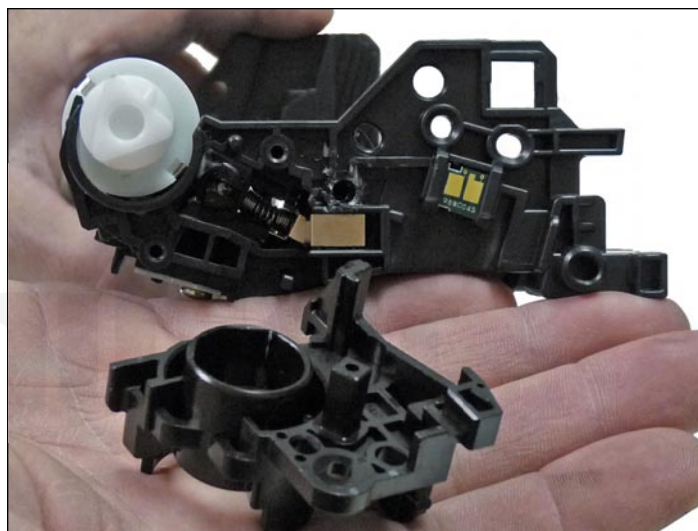



8. Remove the drum.

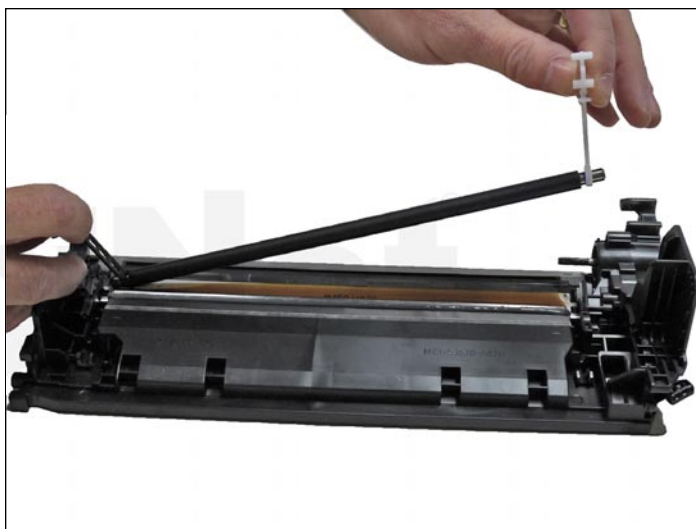

9. Remove the PCR by lifting up on the black and white PCR locking arms. Remove the PCR assembly.

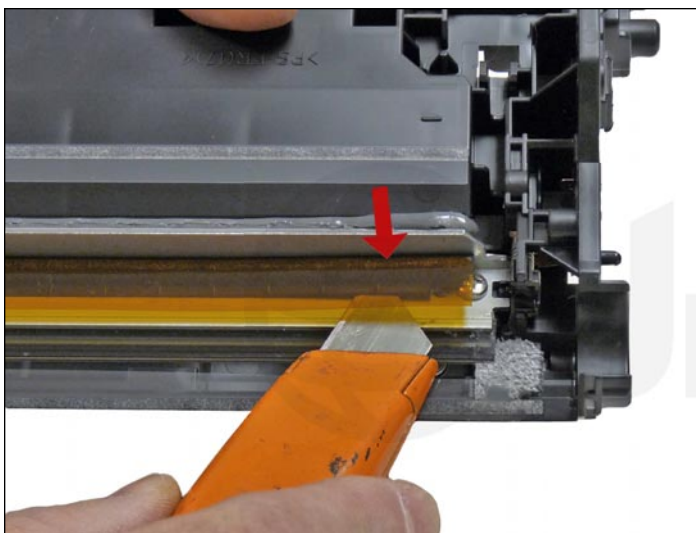

10. To remove the wiper blade, the amber film assembly needs to be removed. Slide a razor knife under the plastic mounting bar as shown.

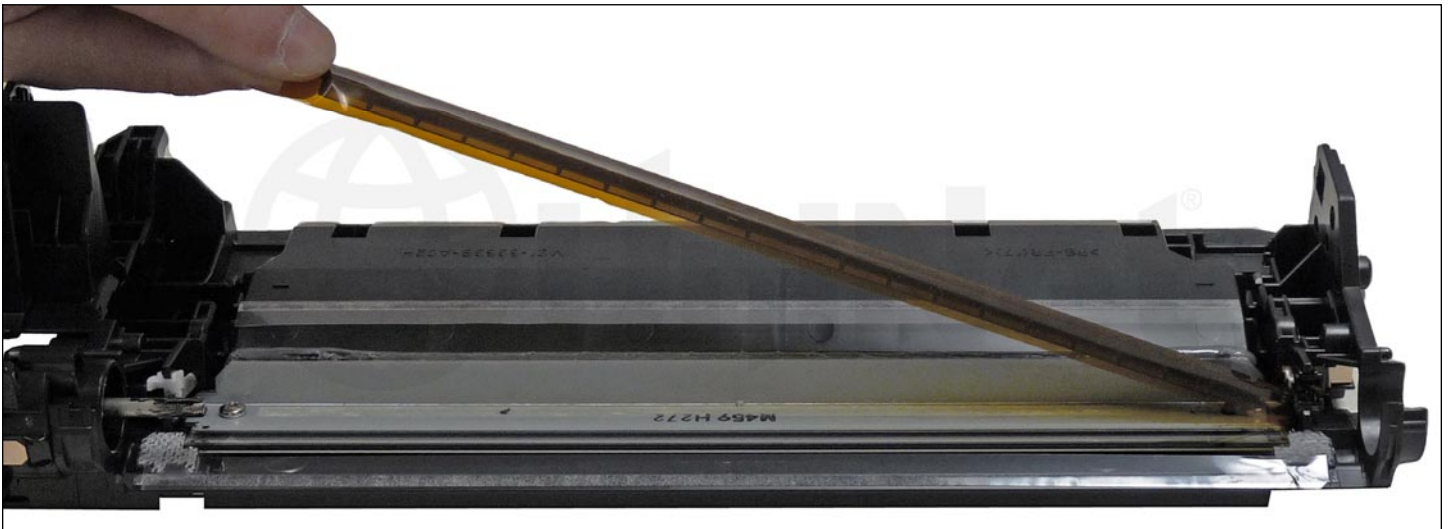

Remove the assembly.

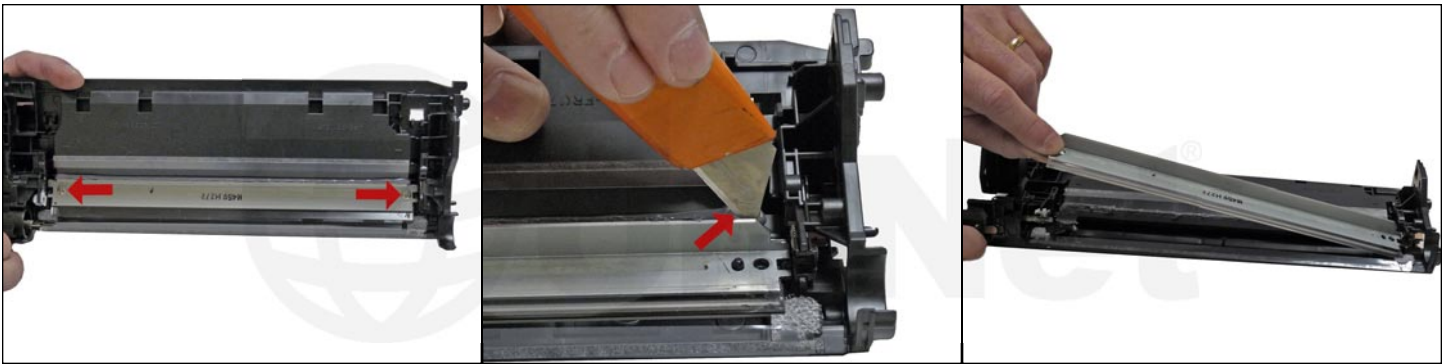

11. Remove the two screws from the wiper blade. Slide the razor knife along the back edge of the blade to release it from the glue. Remove the wiper blade. Clean out all the waste toner from the chamber. Try not to get any toner on the wiper blade seal if possible.

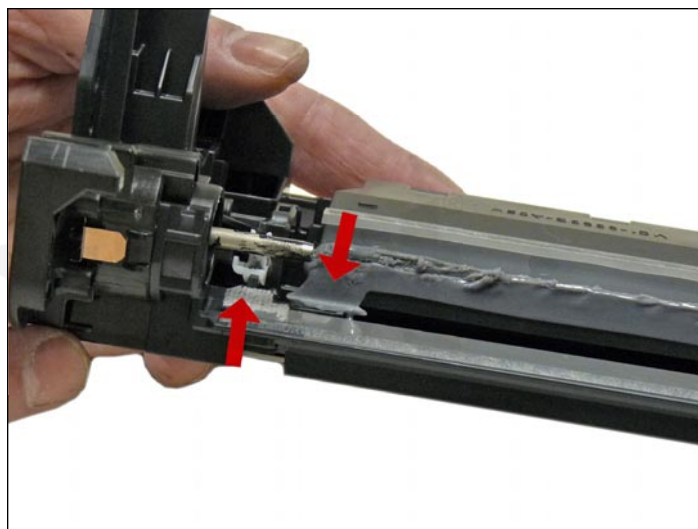
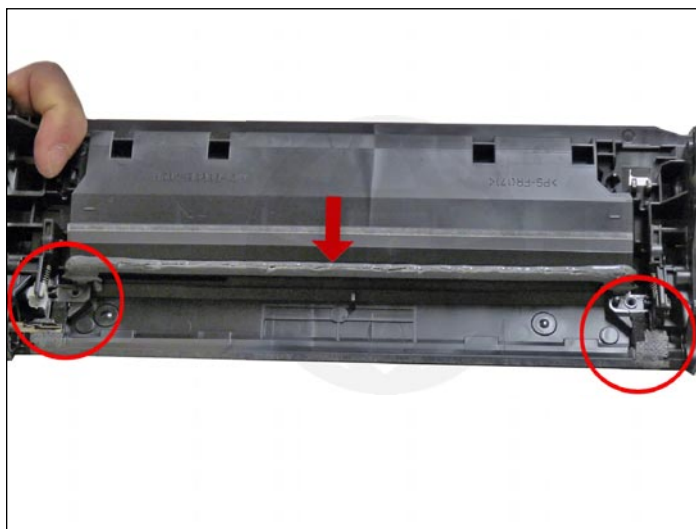

12. Clean the felt seals on each end of the wiper blade. If the wiper blade glue has toner on it, clean it off with alcohol and a foam swab. If it does not become sticky again, it needs to be removed and a good silicone caulk used to seal the blade off. GE 100% Silicone and Phenoseal are two good brands for this.

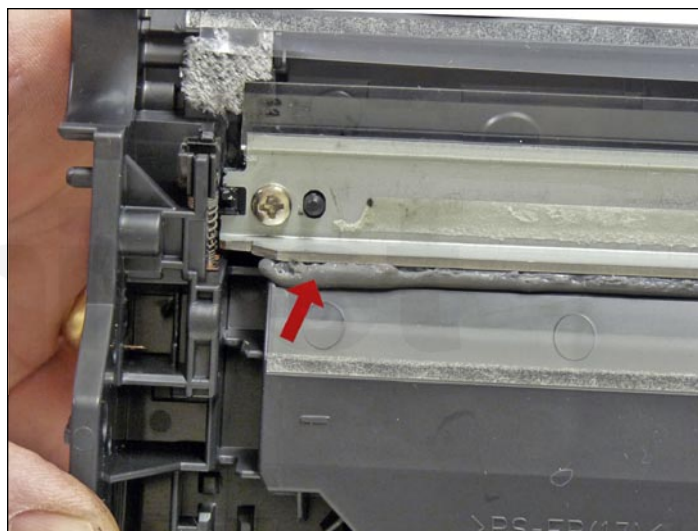
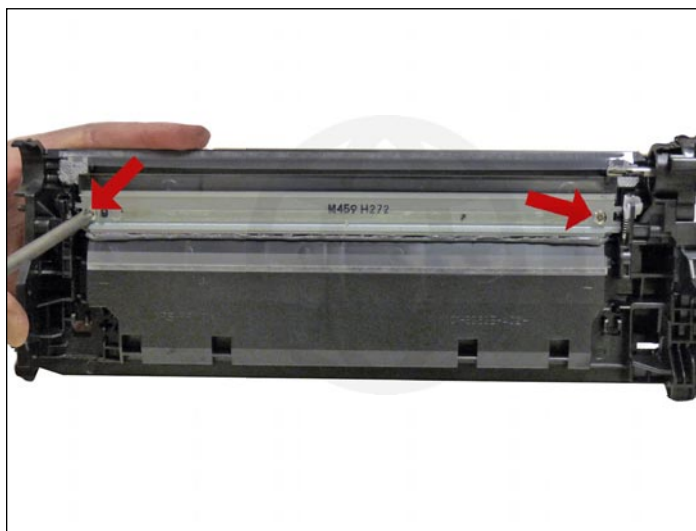

13. Install the new wiper blade and two screws.

If you removed the wiper blade glue, seal the back edge of the blade with the silicone now.



14. The amber film assembly is held in place with double-sided tape. If this is not sticking or a new wiper blade is being used, replace the tape. Replace the film assembly.



15. Clean the PCR with your preferred cleaner and install in the cartridge with the PCR holders.

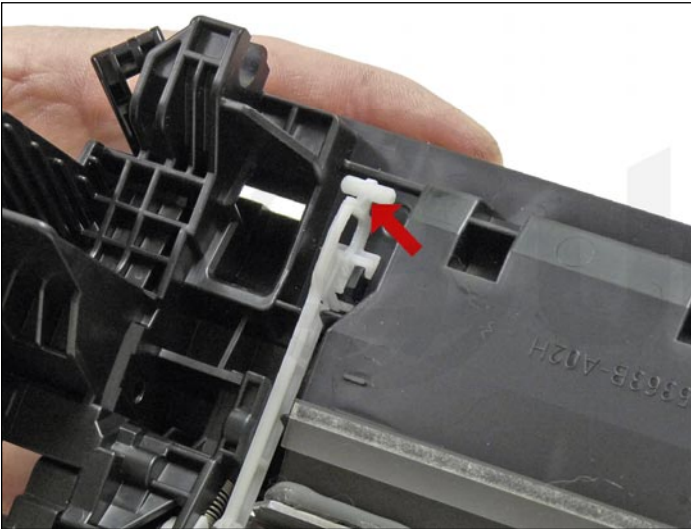

Make sure you lock the locking arms in place.

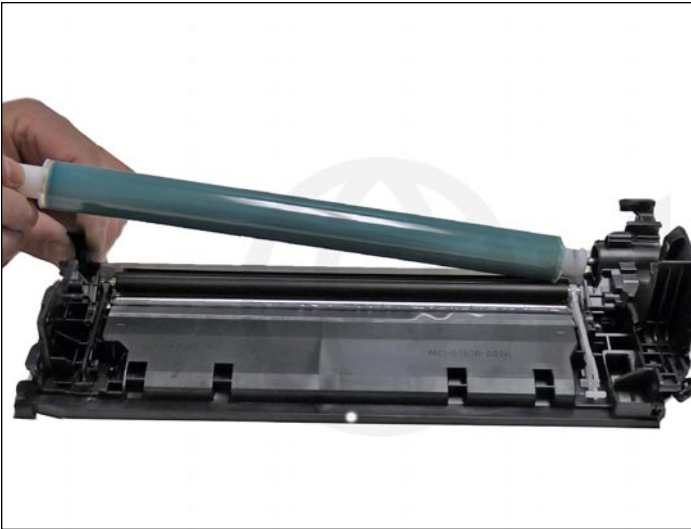

16. Install the drum, short-hub side onto the long drum ground pin.

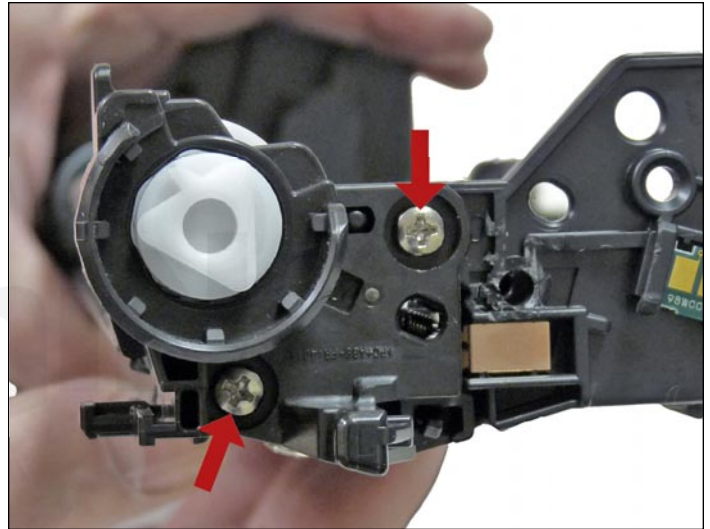

17. Install the end cap and two screws.

Place the waste chamber aside.

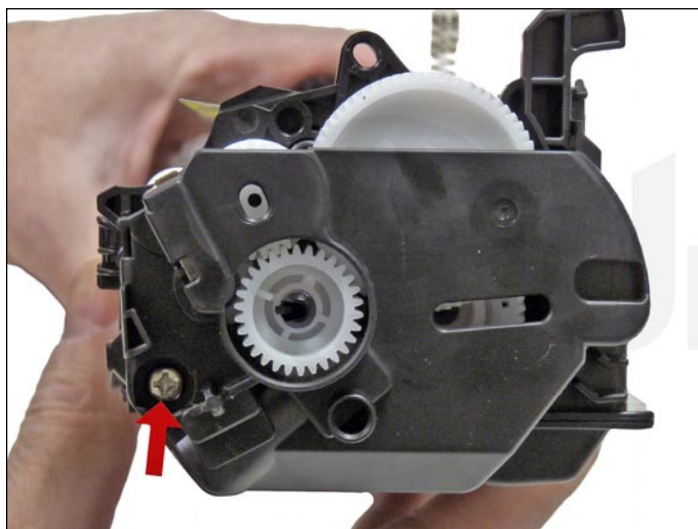

18. On the supply chamber, remove the screw from the gear side end cap.

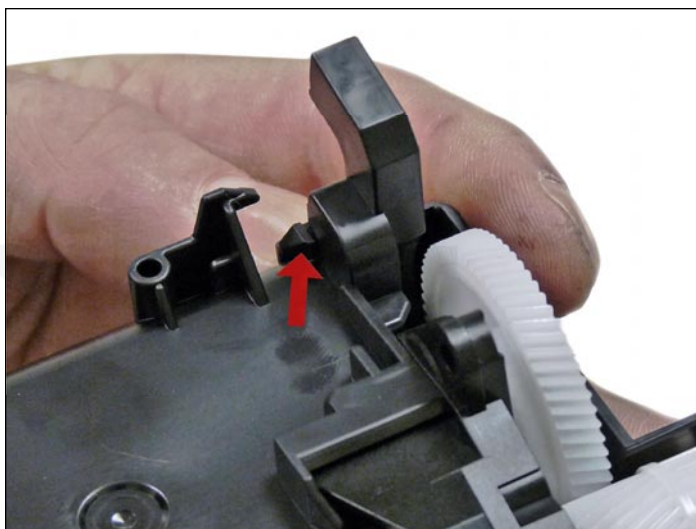

19. Press in on the tab and remove the end cap.

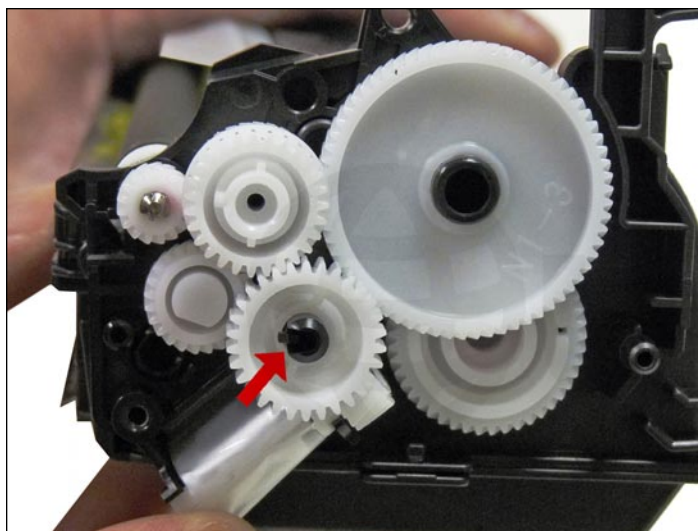

20. On the center gear press on the locking tab to release the gear. Remove all the gears as shown except for the mixing blade gear and the sealing strip gear. The mixing blade gear is attached to the mixing blade inside the hopper and is very difficult to re-attach properly.

UniNet®

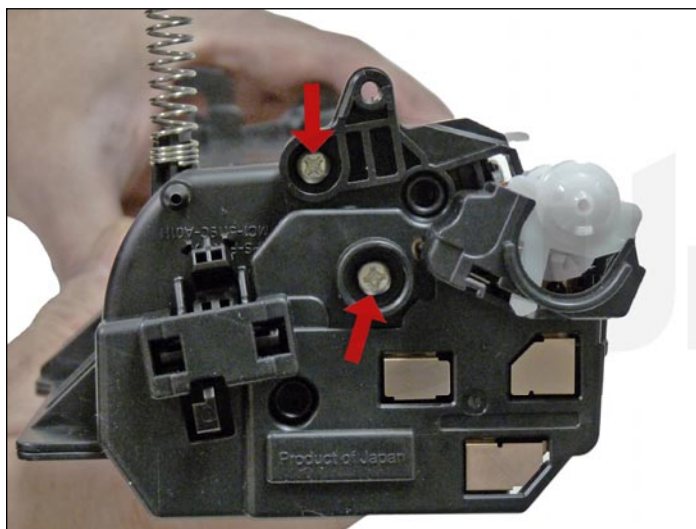

21. Remove the two screws on the contact side.

Press in on the tab and remove the end cap.

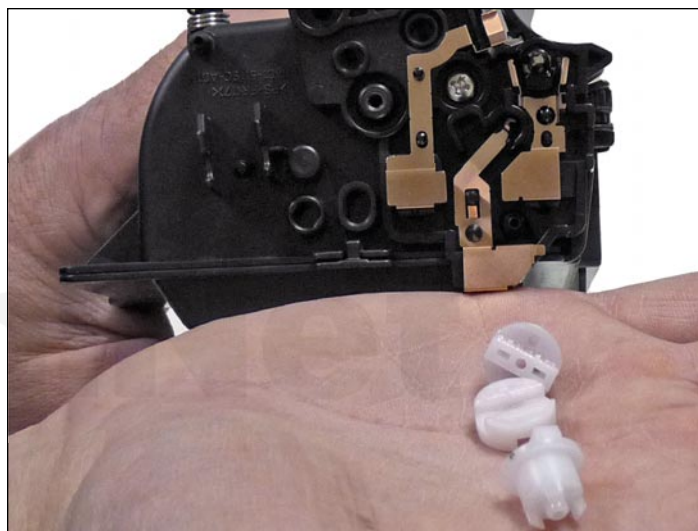
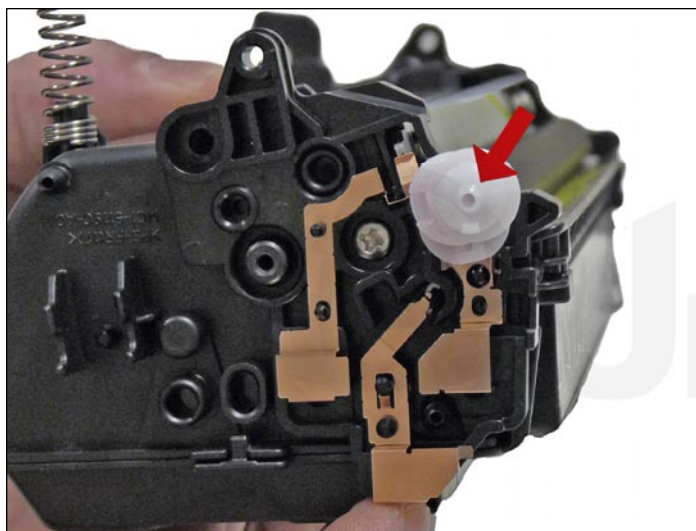

22. Remove the three developer roller drive gears.

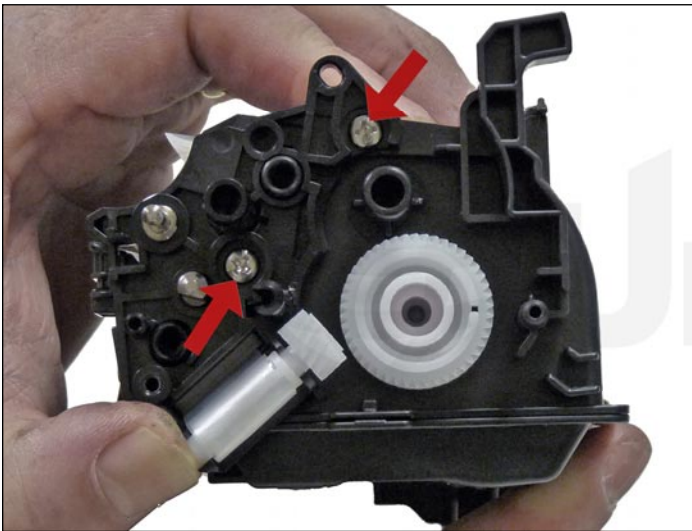

23. On the gear side inner end cap, remove the two screws and end cap.

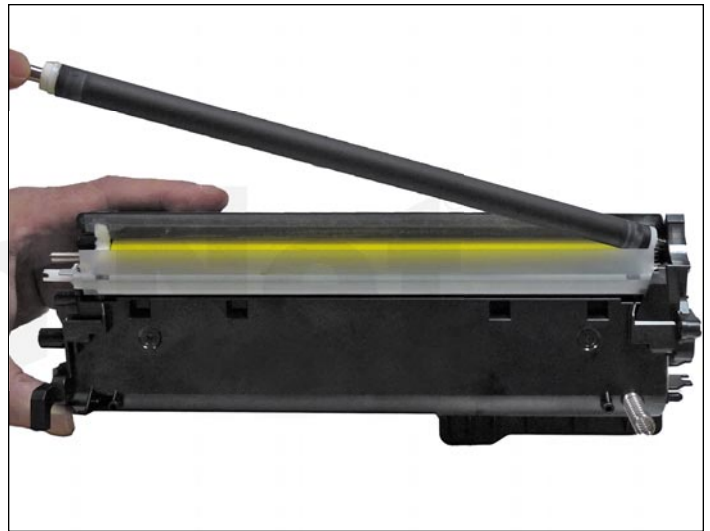

24. Remove the developer roller.

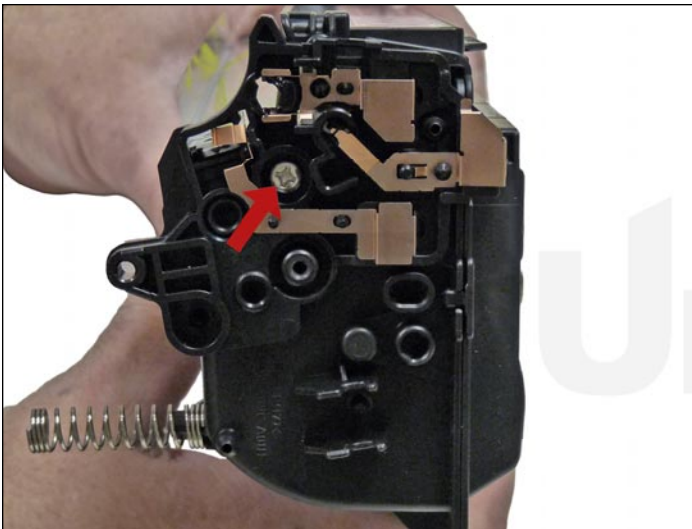

25. Remove the single screw and contact side inner end cap.



26. Remove the two screws from the doctor blade and start to lift the blade up.

There is glue on either end of the blade.

As you lift the blade up, slice the glue away from the blade with the razor knife.

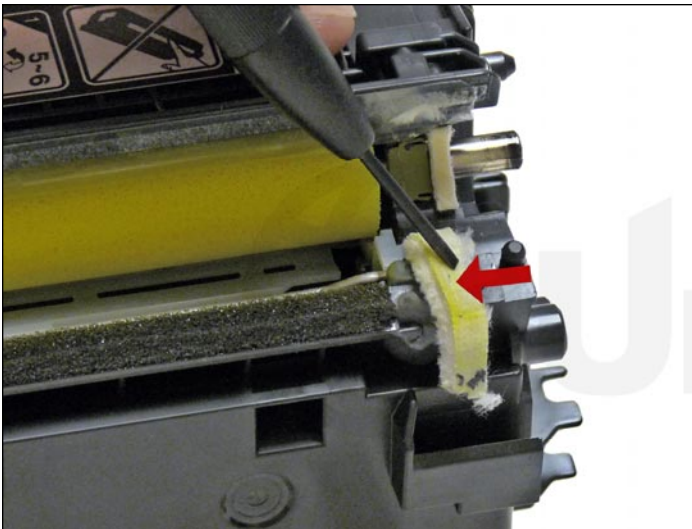

27. On the right side of the chamber lift up the felt developer roller seal. Lift it from the front side and lay it over the back



28. Remove the white felt washers from both sides of the feed roller.

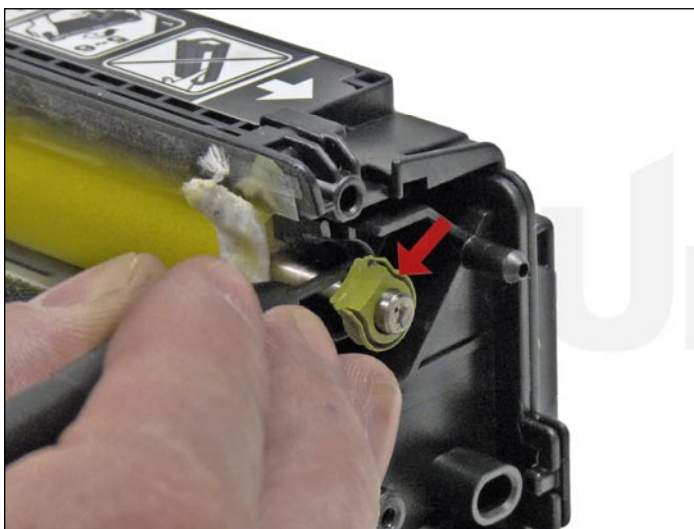

29. Pry out the rubber feed roller bushing from the right side.



30. Remove the feed roller.

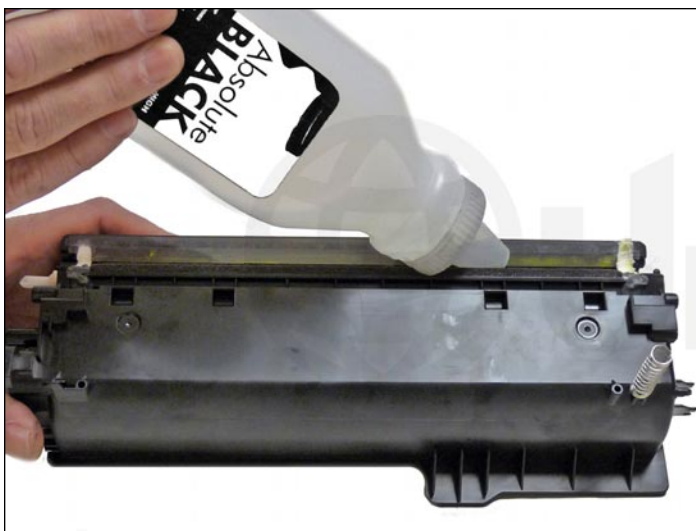

31. Clean out the remaining toner and fill with the correct color of dedicated toner for use in CM4540.

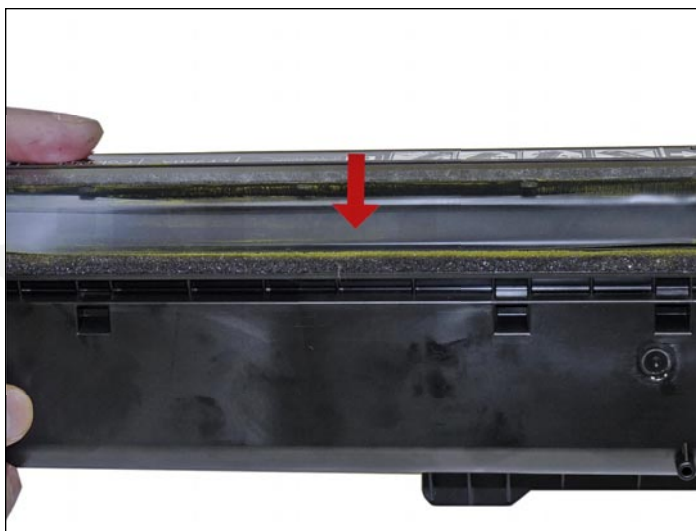

32. When a seal is available, install the seal onto the seal rails. Pull the release tape off one-inch at a time and press the seal in place as you go.

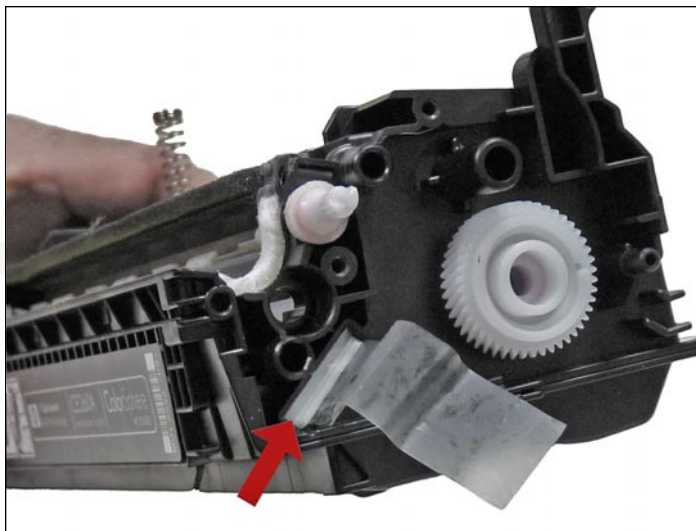
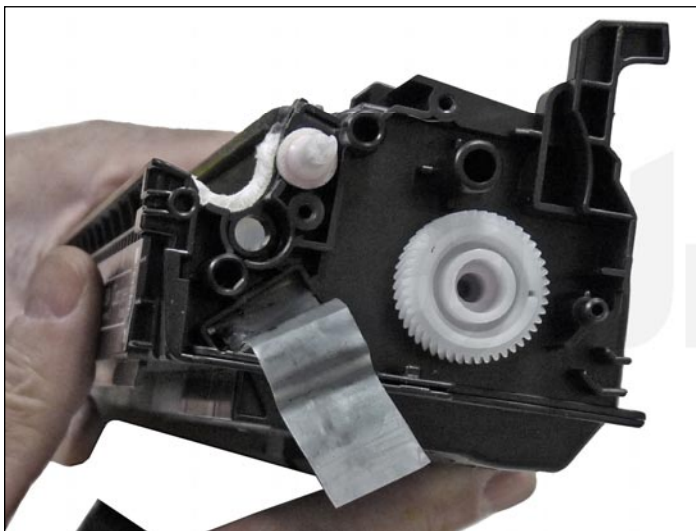

33. Remove the seal port and slide the seal pull-tab through the slot. Install the seal port.



34. Install the feed roller and rubber bushing.

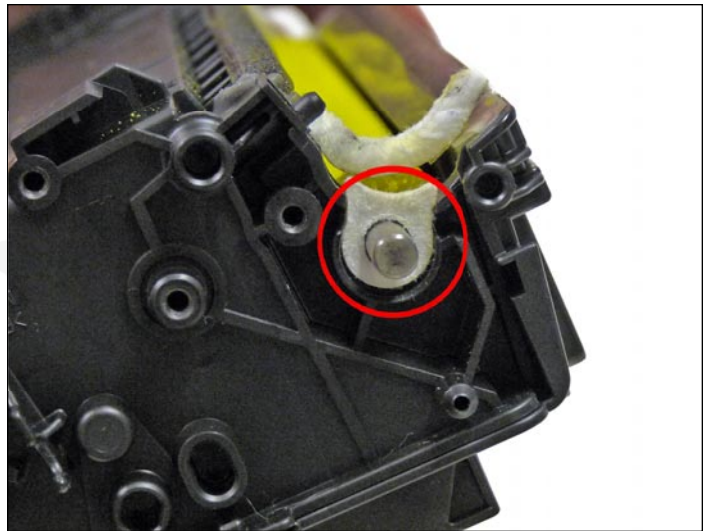

35. Install the feed roller felt washers.

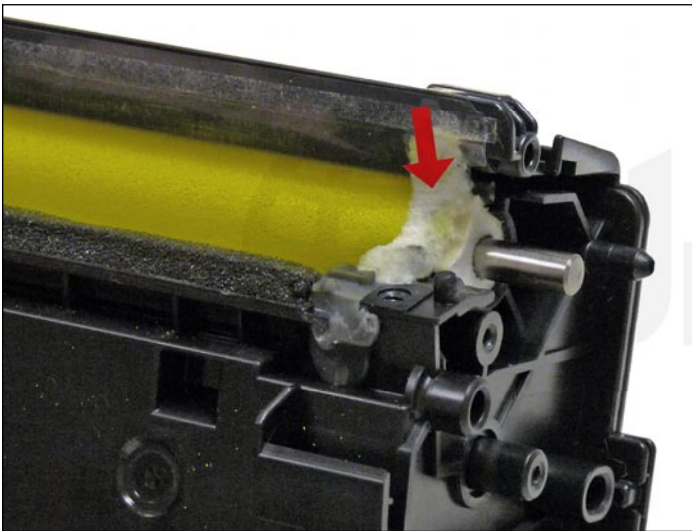

36. Press the developer roller felt seal back in place. Make sure it fits under the retaining blade.

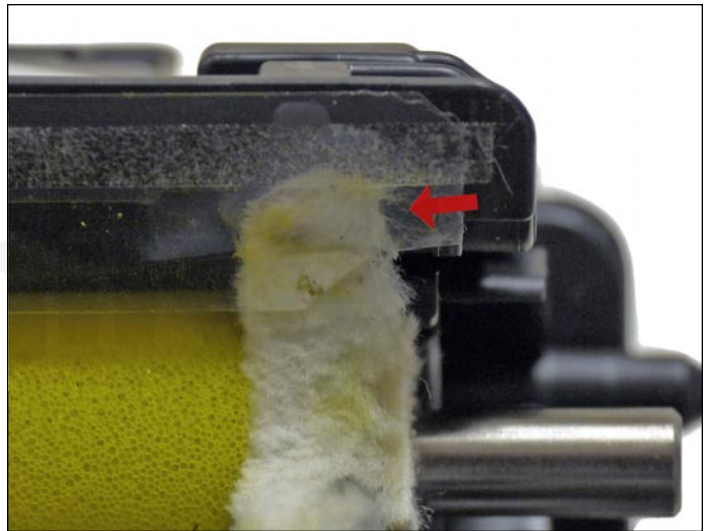

If needed, clean the adhesive with alcohol and a foam swab.



37. Use the appropriate shims to gap the blade and install the doctor blade and two screws. Make sure the sticky seals on either end of the blade seal correctly. If the material is no longer sticky clean it with alcohol or replace it with a small amount of silicon.

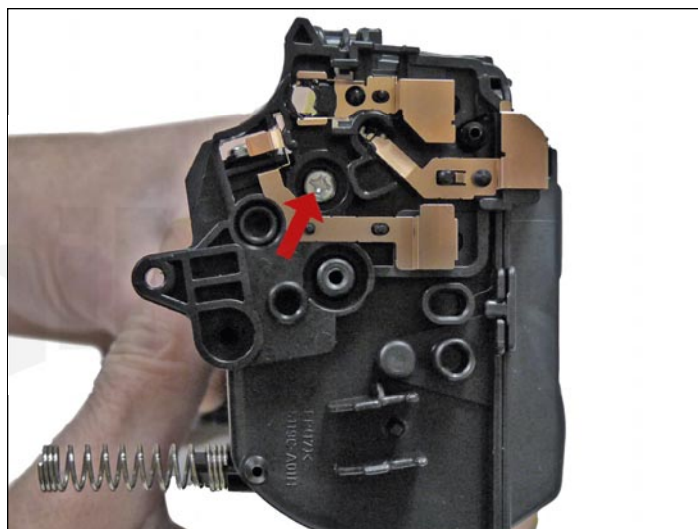

38. Clean the contacts and replace the conductive grease on the inner contact end cap. Install the inner contact end cap and screw.



39. Install the cleaned developer roller. Do not use any chemicals to clean this. A lint free cloth works fine.

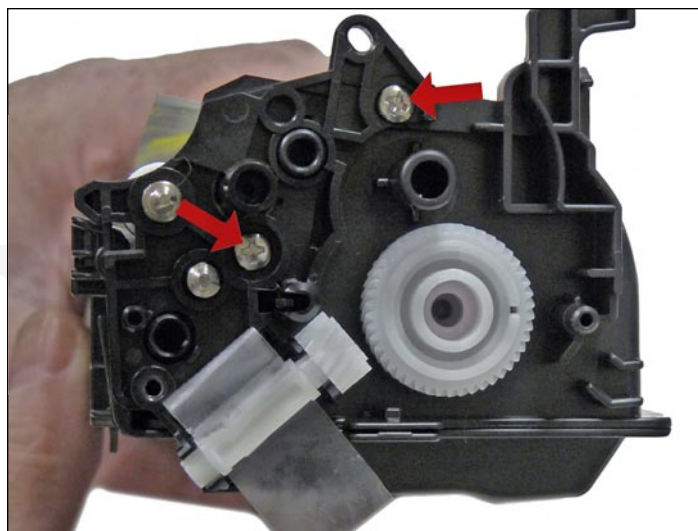

40. Install the inner gear end cap and two screws.

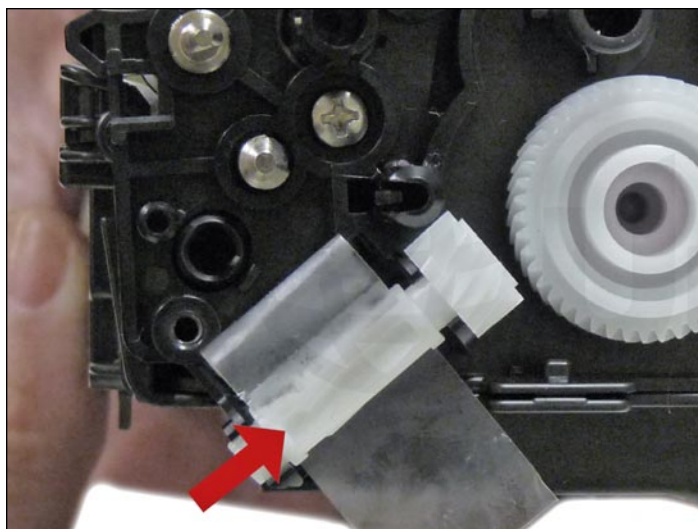

41. Install the gears in the order shown. If you installed a seal, slide the seal end through the take up gear and wrap the loose tail tight on the roller.

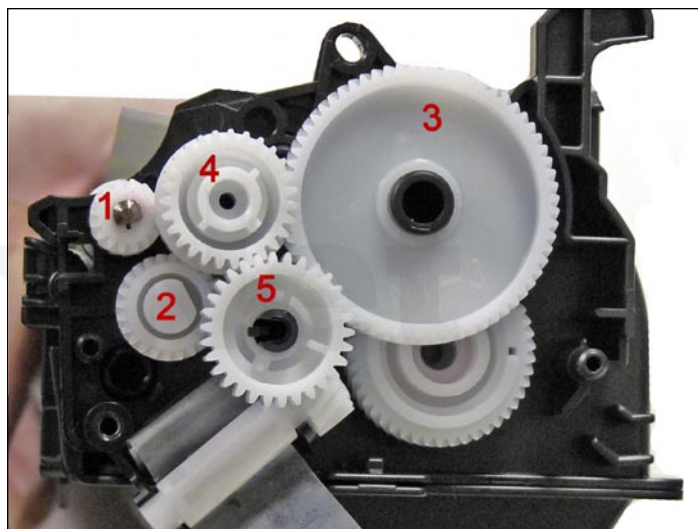

42. Install the remaining gears in the order shown.

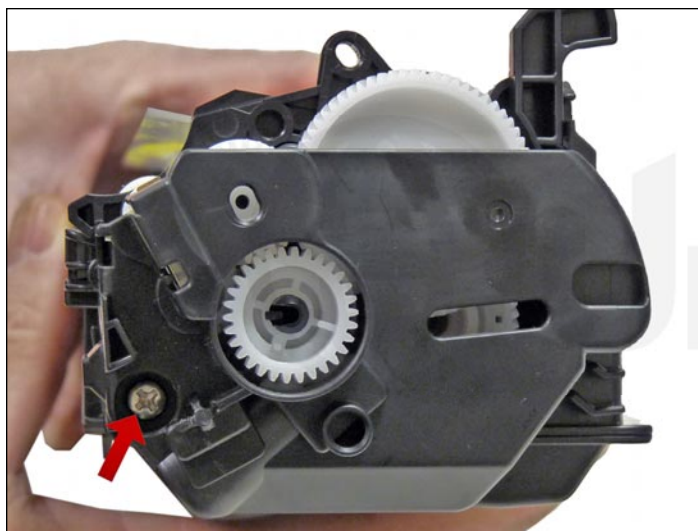

43. Install the outer gear end cap and screw.

UniNet®

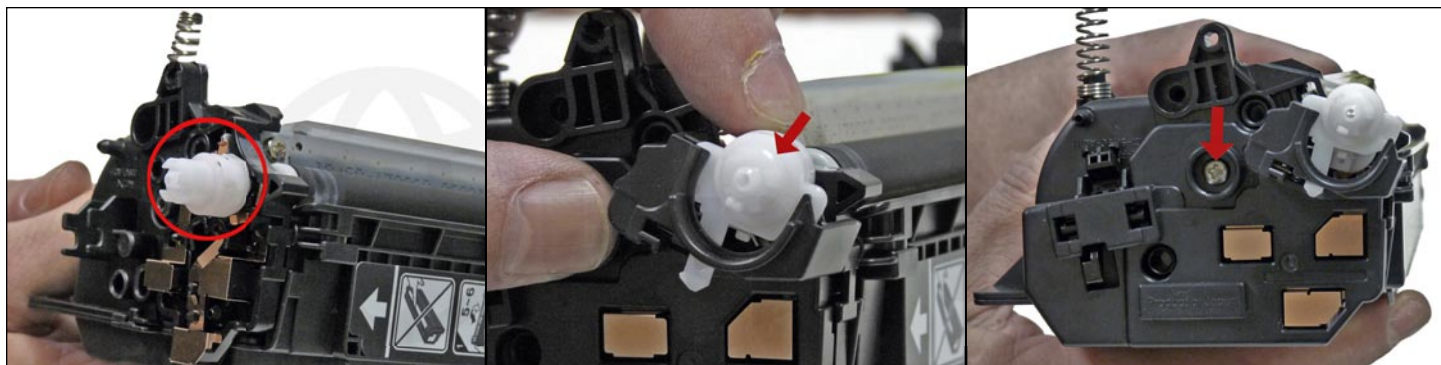

44. Place the triple gear on the developer roller shaft and fit into the spring assembly on the end cap.

Install the opposite side end cap and install the screw.

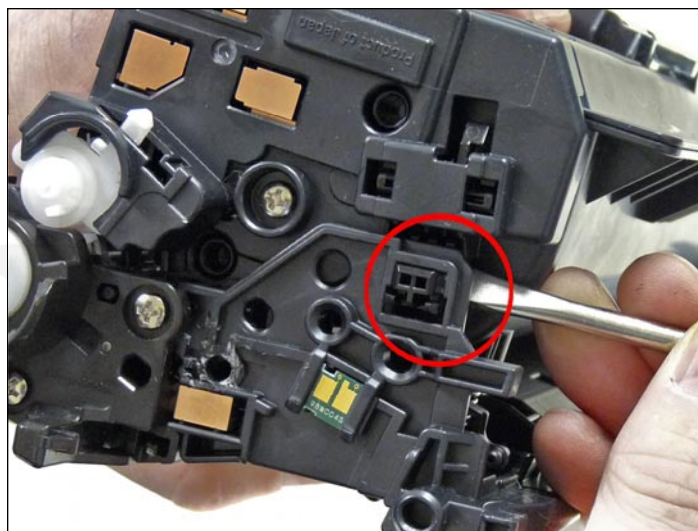

45. Place the two halves together contact side first. On the gear side, press the lever in place.

On the contact side snap the lock up into the end cap.



46. Install the two pins.

Large pin goes to the label or gear side of the cartridge.



47. Install the spring.

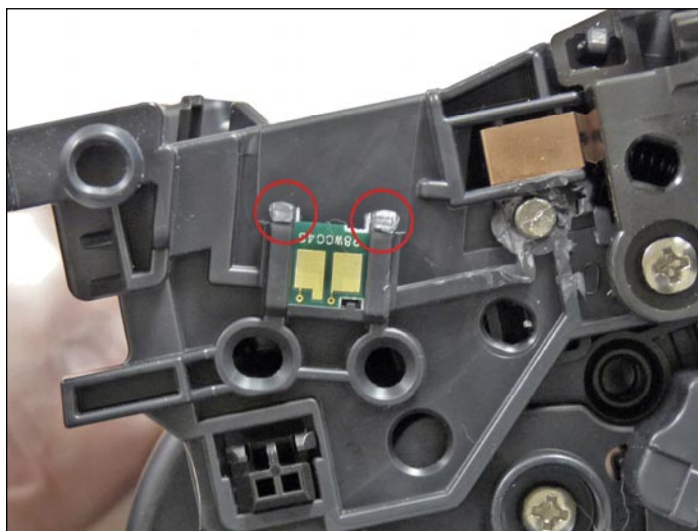

48. Remove the chip by cutting the plastic off the edges of both side of the chip.

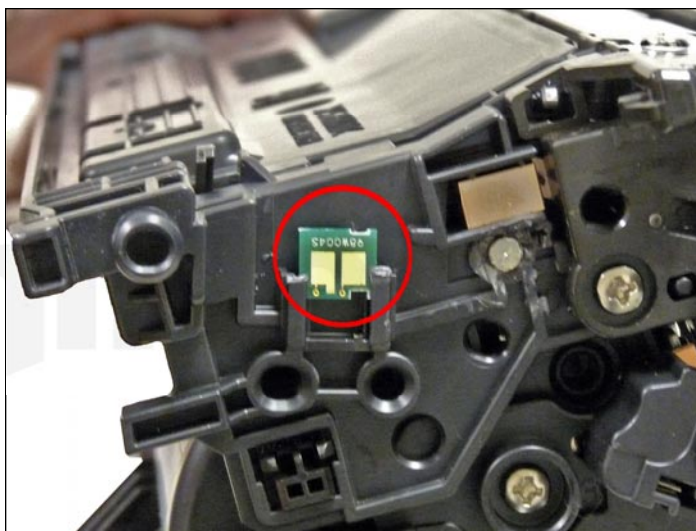

49. Remove and replace the chip. If the new replacement chip is loose in the slot. Close off the top edges with small amounts of hot glue.



50. Install the drum cover on to the cartridge.

TAKING TEST PRINTS

Configuration Page:

1. Scroll to and touch the Administration button
2. Open the following menus: Reports / Configuration/Status Pages / Configuration Page
3. Touch the Print button
4. Print Quality TEST PAGES
5. Scroll to and touch the Administration button
6. Scroll to and touch the Troubleshooting button
7. Touch the Print Quality Pages button
8. Touch the PQ Troubleshooting Pages button
9. Touch the Print button
10. Follow the instructions on the pages that print out.

Diagnostics Page:

1. Scroll to and touch the Administration button
2. Scroll to and touch the Troubleshooting button
3. Touch the Print Quality Pages button
4. Touch the Diagnostics Page button
5. Touch the Print button
6. Follow the instructions on the pages that print out.

Cleaning Page:

1. From the Home screen: touch the device Maintenance Button
2. Open the following menus: Calibrate/Cleaning / Cleaning Page
3. Touch the Print button
4. The cleaning process will take several minutes

REPETITIVE DEFECT CHART

NOTE: The HP service manual is less than helpful on repetitive defects with their current chart. The first description column shows HP's description. We have added what we know in the second description column, which is based on the older HP CP4025 service manual and our tests.

Distance	HP Description	Our Description
27.0 mm	Print cartridge	Primary charge roller
32.0 mm	Print cartridge	Developer roller sleeve
44.0 mm	Transfer unit	Secondary transfer unit
48.0 mm	Print cartridge	
51.0 mm	Transfer roller	Primary transfer roller
55.0 mm	Print engine	
63.0 mm	Transfer unit	Secondary transfer backing roller
76.0 mm	Print cartridge	OPC drum
76.0 mm	Fuser	Fuser sleeve
80.0 mm	Fuser	Fuser pressure roller
96.0 mm	Print engine	
101.0 mm	Print engine	