

- **Publications**
  - Dealer Catalog #23
  - Catalog Update
- **Chips**
  - Comprehensive Chip List
  - Lexmark Chip Cross Reference
  - Reset Box Information
    - Samsung Reset Box Compatibility
    - MasterSet USB Installation Software
    - MasterSet Parallel Port Installation Software
- **Product Info**
  - Vacuums
  - Packaging
- **Technical Support**
  - Disassembly Instructions
  - Reset Guide Ver. 16
  - Cross Reference Ver. 9 Update
  - Engine Cross References
    - HP
    - Lexmark
    - Samsung
  - Common Terms & Acronyms
  - Cartscan
- **Customer Service**
  - Company Profile
  - Customer Forms
  - Non-Customer Quote
  - Join Email Group
  - International Sales
  - International Distributors
  - Terms & Conditions
  - Track Your Order
  - Contact Us
- **Go to Uninetimaging.com**

## Remanufacturing the Xerox 4525 Toner Cartridge



- **Overview**
- **Supplies Required**
- **Tools Required**
- **Disassembly**
- **Taking Test Prints**
- **Cartridge Troubleshooting**

## Remanufacturing the Xerox 4525 Toner Cartridge

0317

First released in April 2001, the Xerox 4525 is based on a 45 ppm 1200 Dpi engine. While it looks like an N24 cartridge there are differences, but most importantly the toner is different. The higher speed of these machines calls for a toner that melts at a different temperature than the N24. Most of the other parts used in the cartridge are standard N24, but the toner is not.

Machines based on the Xerox 4525 engine are as follows:

Lexmark W820, 820DN, 820E, 820N Cartridge # 12B0090

IBM InfoPrint 1145, 1145DN, 1145N Cartridge # 28P1882

Xerox DocuPrint N4525, 4525BX, 4525CN, 4525FM Cartridge # 113R00195

All three cartridges are rated for 30,000 pages at 5% coverage.

Acom also makes a MICR Enhanced version of the Xerox 4525, but as of now, no toner or chips are available for it.

These cartridges all use N24 type chips that must be replaced each cycle. Each cartridge has its own chip. Make sure you know which machine your customer has before installing the chip. The cartridge will not print if the wrong chip is installed.

Unlike the N24 cartridges, these do not have all the variations to worry about. They are very simple to do, work great and with a list price of \$372.00, very profitable!

Running test prints as well as cartridge troubleshooting will be covered at the end of this article.

## SUPPLIES REQUIRED



- Toner approved vacuum.
- A small screw driver (Common Style)
- A Phillips head screwdriver with removable tips
- Needle Nose Pliers

## TOOLS REQUIRED



- W820 Dedicated Toner
- Magnetic Roller Cleaner
- New replacement chip (See Text)
- New Long Life N24 Drum
- New N24 PCR [Optional]
- New N24 Wiper Blade
- New N24 Doctor Blade [Optional]

## DISASSEMBLY



- 1) Vacuum the exterior of the cartridge.
- 2) On each side of the cartridge there is a large metal pin.
- 3) Carefully pull these pins out using either a pair of needle nose pliers or wire cutters. See Figure's 1 & 2
- 4) Remove the Waste Chamber and put the toner hopper aside. See Figure 3
- 5) Remove the two screws on each side of the drum axle plates, remove the Plates. See Figure's 4 & 5

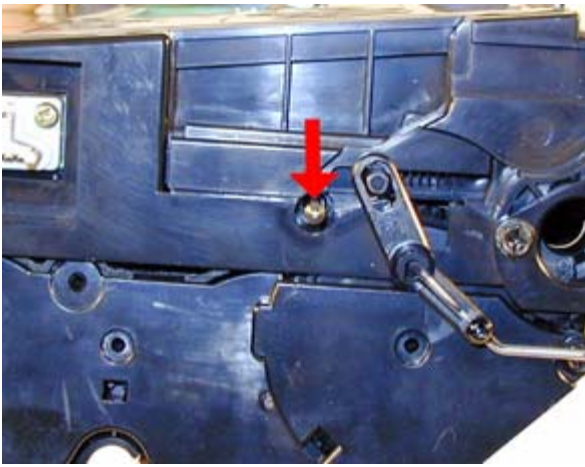

Figure 1

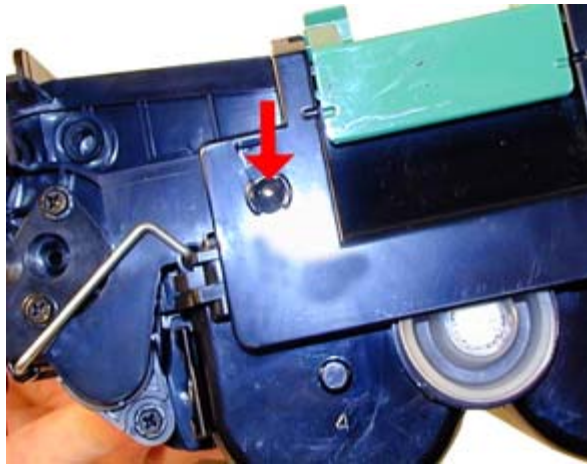

Figure 2



Figure 3



Figure 4

6) Remove the Drum from the cartridge. See Figure 6

7) Remove the Primary Charge Roller (PCR). Clean with your preferred PCR cleaner. See Figure 7

8) Remove the top cover of the Waste Chamber by removing the 4 screws. One is hidden under the label, and one is under the handle. See Figure 8

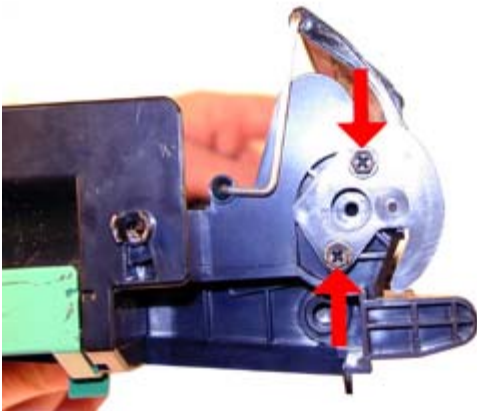

Figure 5



Figure 6



Figure 7

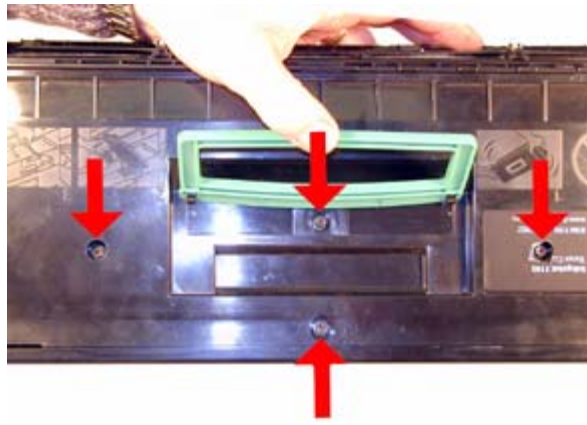

Figure 8

9) Remove the tape seal from the right side. Pry the cover up from the bottom edge. See Figure's 9 & 10

10) Clean all the toner out of the waste chamber.

**NOTE:** Be very careful not to bend or otherwise damage the small thin recovery blade located next to the Wiper Blade when vacuuming. If this blade is bent down lower than the height of the wiper blade, toner will accumulate on top of the blade and spill into the printer. If the blade does get bent, it should be replaced.

11) Remove the Wiper Blade (2 screws and spacers, lift up and out). DO NOT lose the spacers! This blade has a tight fit, work it loose from both edges and lift out. See Figure's 11 & 12

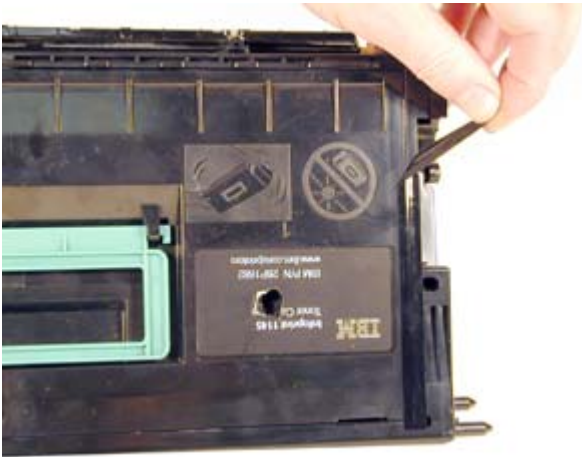

Figure 9



Figure 10



Figure 11

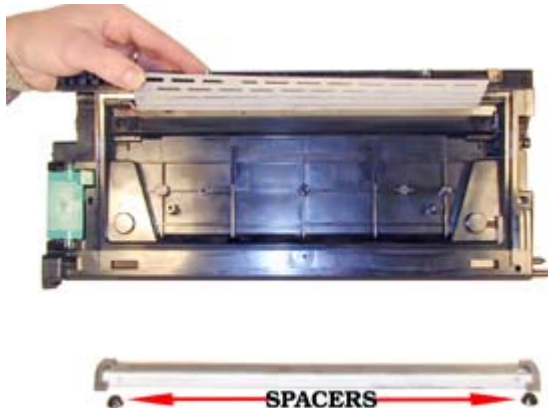

Figure 12

12) Coat the NEW wiper blade with your preferred lubricant and install. See Figure 13

13) Replace the two screws and spacers. Make sure the flat side of the spacers is facing the foam. That way the foam will not be pinched by the spacer possibly causing a leak. See Figure's 14 & 15

14) Install the top cover front edge first. Press down so the back tabs lock in place, install the four screws, and the tape seal on the right side. See Figure's 16, 17 & 18



Figure 13

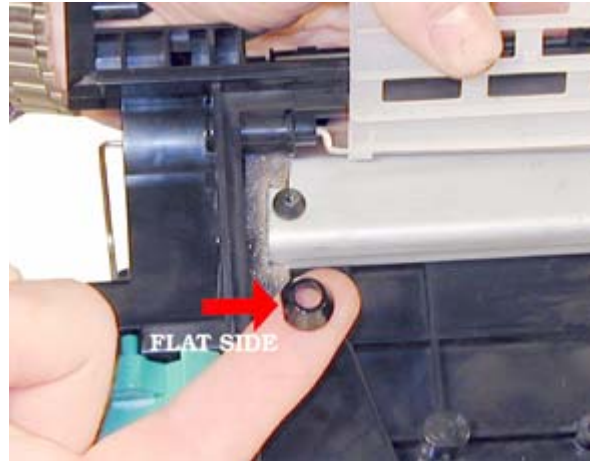

Figure 14

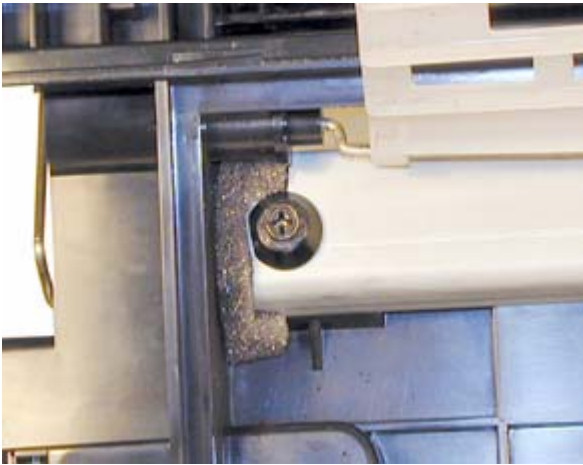

Figure 15



Figure 16

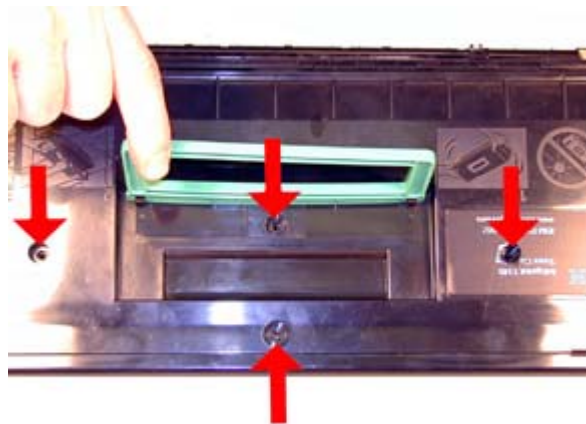

Figure 17

15) Install the cleaned PCR. See Figure 19

16) Install the white gear side of the drum to the white PCR holder side of the cartridge. See Figure 20

17) Install the two drum end caps, and screws. See Figure's 21 & 22



Figure 18

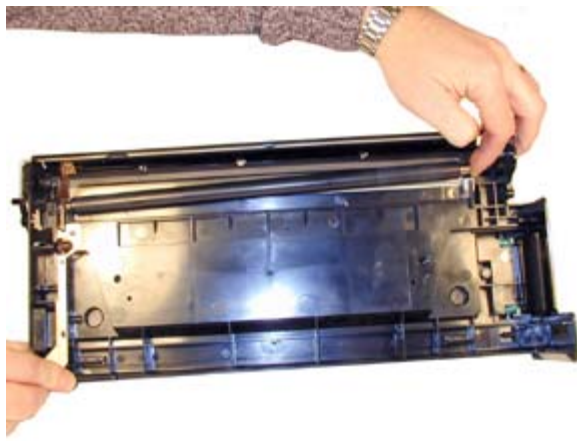

Figure 19



Figure 20

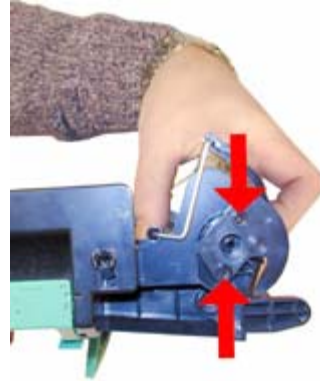

Figure 21

18) Remove the fill plug, and dump any remaining toner out.

19) On the small drive gear side of the supply chamber, remove the screw, and Magnetic roller end cap. See Figure 23

20) Carefully remove the magnetic roller, vacuum clean and place aside. See Figure 24

21) Remove the two screws and DR blade. See Figure 25

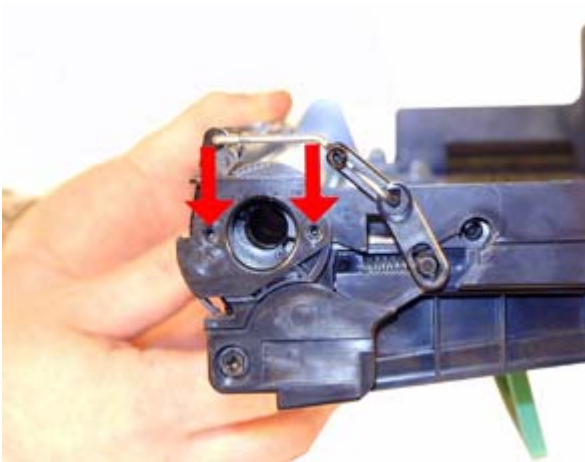

Figure 22

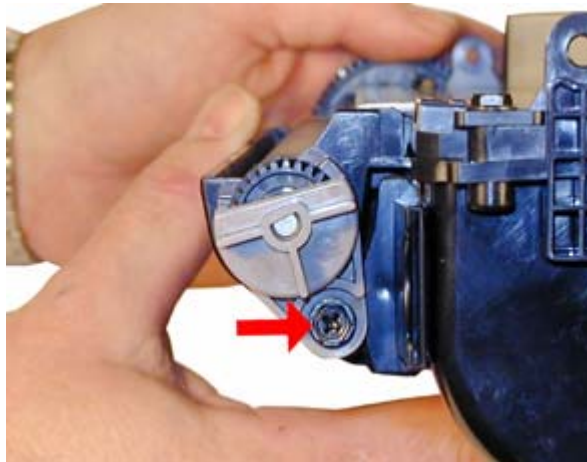

Figure 23



Figure 24



Figure 25

22) Vacuum the Toner hopper thoroughly.

23) Install the seal so that the tail is on the small drive gear side. Make sure the tail fits into its slot, and comes out through the seal channel. See Figure's 26 & 27

24) Fill the hopper with 1350g of dedicated W820 toner. As explained in the beginning of this article, normal N24 toner will not work in these cartridges due to the higher printing speed of the machines. Check for leaks. See Figure 28

25) Replace the DR blade and two screws. See Figure 29

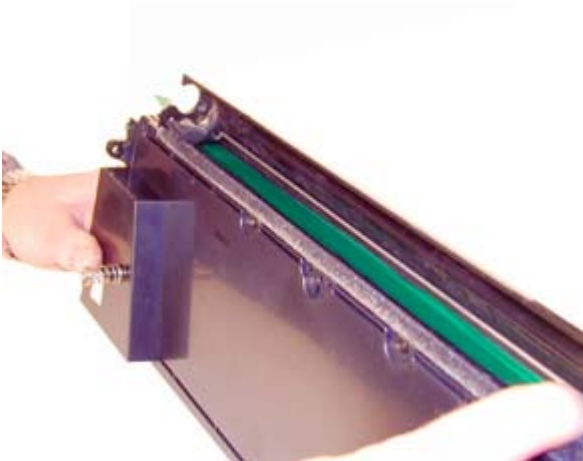

Figure 26



Figure 27



Figure 28



Figure 29

26) Turn the bushing on the magnetic roller assembly so that the curved side is facing up. Pull it away from the roller slightly, and install the entire assembly into the hopper. Press the bushing in so that it is seated properly, and press the drive gear back on the keyed shaft. See Figure's 30, 31 & 32

27) Install the end cap and screw. Note that both the end cap and Magnet shaft are keyed. Make sure that the roller turns freely. See Figure 33

28) Re-assemble the cartridge by placing the two halves together. Make sure that the springs fit into their respective holes. See Figure 34

29) Install the two large hinge pins into each side. See Figure's 35 & 36

30) Replace the chip with the correct chip for your cartridge. The IBM 1145, Lexmark W820, and Xerox 4525 all use different chips. See Figure 37



Figure 30

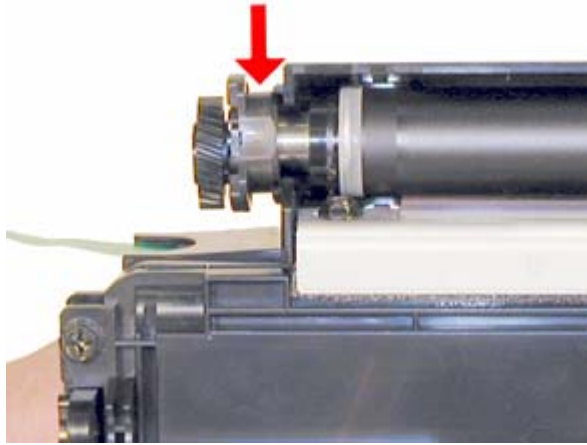

Figure 31

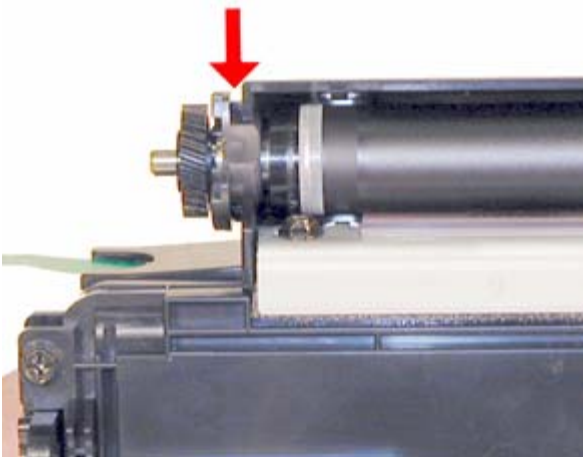

Figure 32



Figure 33

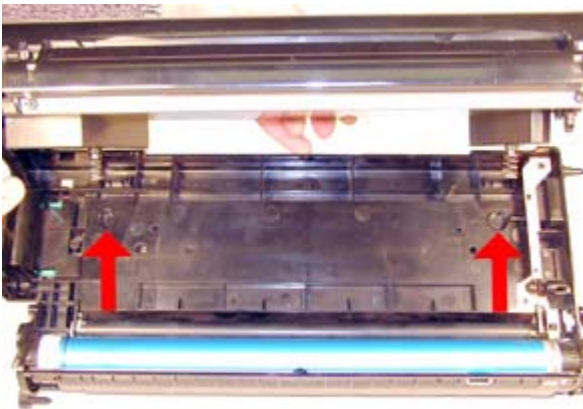

Figure 34

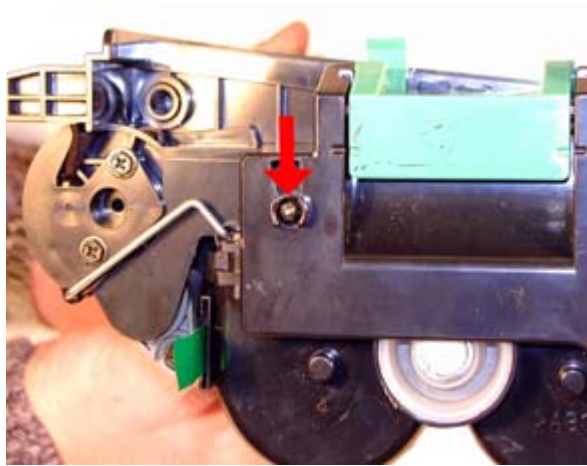

Figure 35



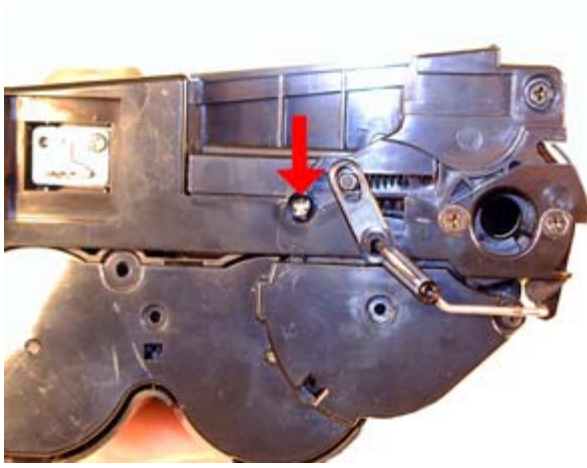

Figure 36

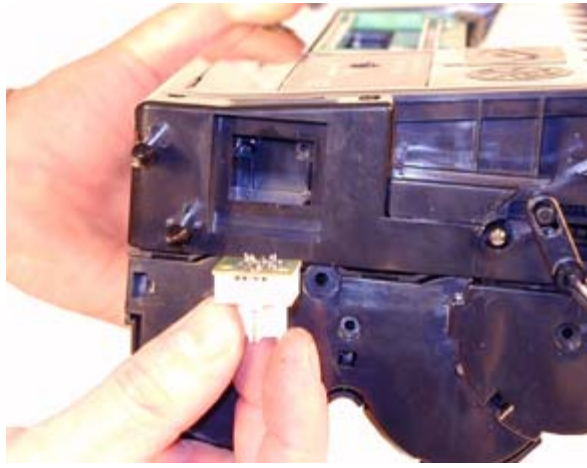

Figure 37

## TAKING TEST PRINTS



Make sure the READY light is on.

Press the "MENU" button until Utilities MENU appears on the display.

Press "SELECT"

Press the "MENU" button until either PRINT FONTS or PRINT MENUS appears on the display. Choose the page you want to print, and Press "SELECT".

The chosen page will print out.

## CARTRIDGE TROUBLESHOOTING:



There are no strange or unique issues that we have seen with these cartridges. Normal cartridge problems along with the repetitive defect rate are listed below

**Primary Charge Roller (PCR);** The primary charge roller if dirty will show on the test print as vertical gray streaks down the page, or as a gray background throughout the page. If there is any physical damage, it will repeat at intervals of 44mm.

**A Dirty PCR** Connection will result in dark black horizontal bars across the page, or as shading throughout the page.

**A Scratched Drum** will show up as a very thin, perfectly straight line that runs from the top to the bottom of the test page.

**A Chipped Drum** will result in a dot or series of dots that repeat at 95mm intervals

**A Damaged Magnet Roller Sleeve** will either leave a mark or a blank spot (depending on the type of damage) at intervals of 56mm.

**A Worn Magnetic Roller Sleeve** will cause light prints. (You can normally see the silver through the black coating on a worn mag.)

**A Light Damaged Drum** will show up as a shaded area on the test print that should be white. Again this will repeat at intervals of 95mm.

**A Bad Wiper Blade** will result in vertical gray lines down the page, or as shading across the entire page. In either case there will be a film of toner on the drum surface.

© 2003-2004 Summit Laser Products, Inc. Any attempt to reproduce any part of these instructions without the written consent of Summit Laser Products, Inc is prohibited. All registered trademarks are the property of their respective owners.

**East Coast Distribution Center**  
95 Orville Drive  
Bohemia, New York 11716  
T: 800.221.3516 F: 888.791.9188

**West Coast Sales Office**  
674 County Square Drive #303D  
Ventura, California 93003  
T: 800.211.4238 F: 800.869.8467

**International Sales**  
T: +1 631.590.1040 F: +1 631.218.3285  
© Copyright 2003-2006, Summit Technologies  
All Rights Reserved