

# LEXMARK™ X560

## TONER CARTRIDGE REMANUFACTURING INSTRUCTIONS



LEXMARK X560 TONER CARTRIDGE

# REMANUFACTURING THE LEXMARK X560 TONER CARTRIDGES

By Mike Josiah and the Technical Staff at UniNet

The Lexmark X560 Engine is a multifunction 31 ppm (black) and 20 ppm (color) engine that runs at 600 dpi (2400 dpi image quality). The first page out is stated to be under 11 seconds, and the printer runs off a 400 MHz processor. The memory comes standard at 384MB and is expandable to 1.4GB. These machines can print, scan, fax, copy and duplex.

There are low yield (starter) cartridges and high yield cartridges available. A low yield cartridge cannot be made into a high yield version as there are a set of gears in high yield cartridges not present in the low yield versions. High yield cartridges use a second toner hopper based in the drum section of the cartridge. This hopper is present in the low yield versions, but the necessary gears to move the toner are not.

These cartridges have a chip that must be replaced each cycle. In addition, they also have gears on the supply hopper(s) that must be set correctly for the cartridge to work.

The printers ship with a set of starter cartridges. Both the color and black cartridges are rated for 4,000 pages.

## CURRENT MACHINES BASED ON THE X560 ENGINE

**Lexmark X560n**

**Lexmark X560dn**

## CARTRIDGES USED IN THESE MACHINES

<b>0X560A2KG</b>	<b>Black LY Cartridge (4000 pages)</b>	
<b>0X560A2CG</b>	<b>Cyan LY Cartridge (4000 pages)</b>	
<b>0X560A2MG</b>	<b>Magenta LY Cartridge (4000 pages)</b>	
<b>0X560A2YG</b>	<b>Yellow LY Cartridge (4000 pages)</b>	
<b>0X560H2CG</b>	<b>Cyan HY Cartridge (10,000 pages)</b>	<b>\$412.65 List*</b>
<b>0X560H2MG</b>	<b>Magenta HY Cartridge (10,000 pages)</b>	<b>\$412.65 List*</b>
<b>0X560H2YG</b>	<b>Yellow HY Cartridge (10,000 pages)</b>	<b>\$412.65 List*</b>
<b>0X560H2KG</b>	<b>Black HY Cartridge (10,000 pages)</b>	<b>\$278.25 List*</b>

\*List pricing in U.S. American Dollars.

As you can see, these are extremely profitable cartridges to remanufacture. These cartridges use both toner and developer in the cartridges. This system is a little different so we are including the cartridge/printer theory here.

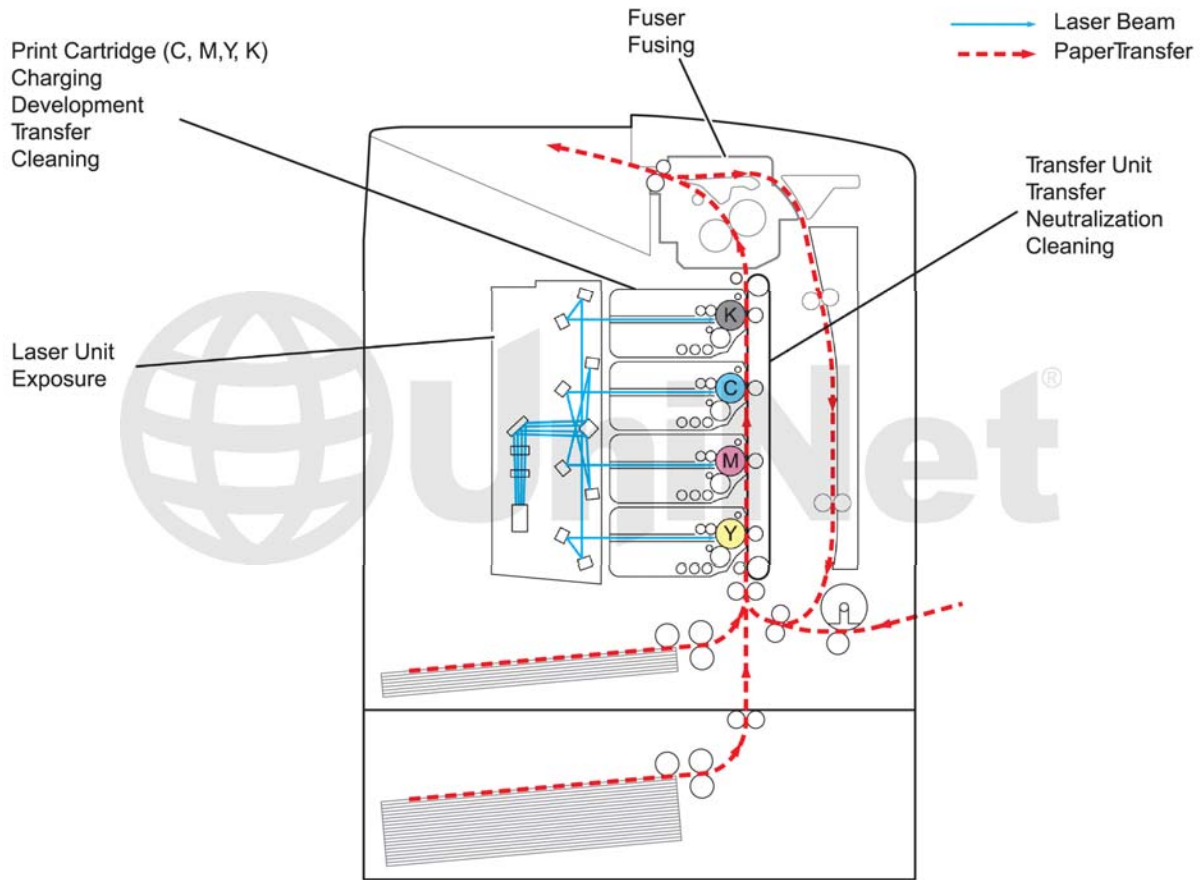

Shown is a basic layout of the cartridges as they relate to the printer. Also listed are the steps used in the printing process.

These steps are covered in more detail as follows.

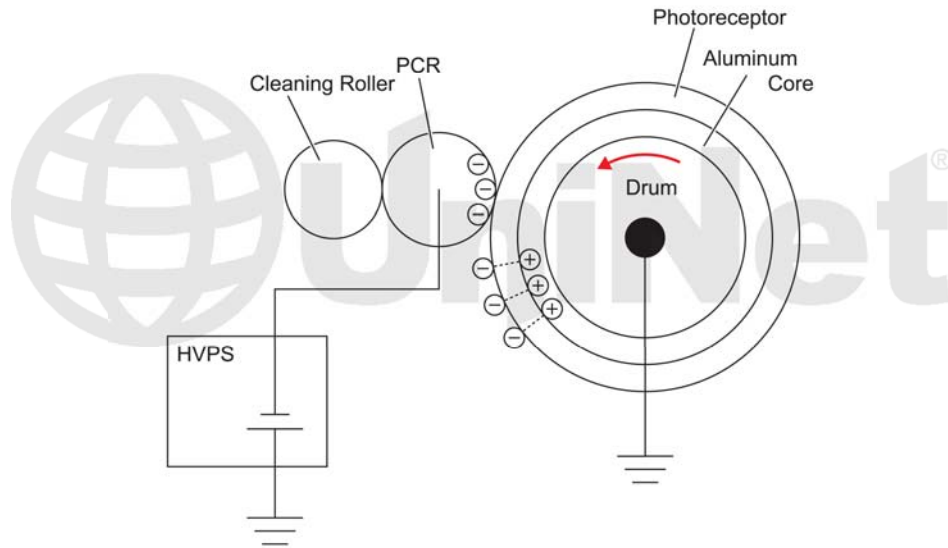

In the **first** stage, the Primary Charge Roller (PCR) places a uniform negative DC voltage on the OPC drum surface. The amount of the negative DC voltage placed on the drum is controlled by the printer's intensity setting. The PCR cleaning roller removes any toner or paper dust from the PCR.

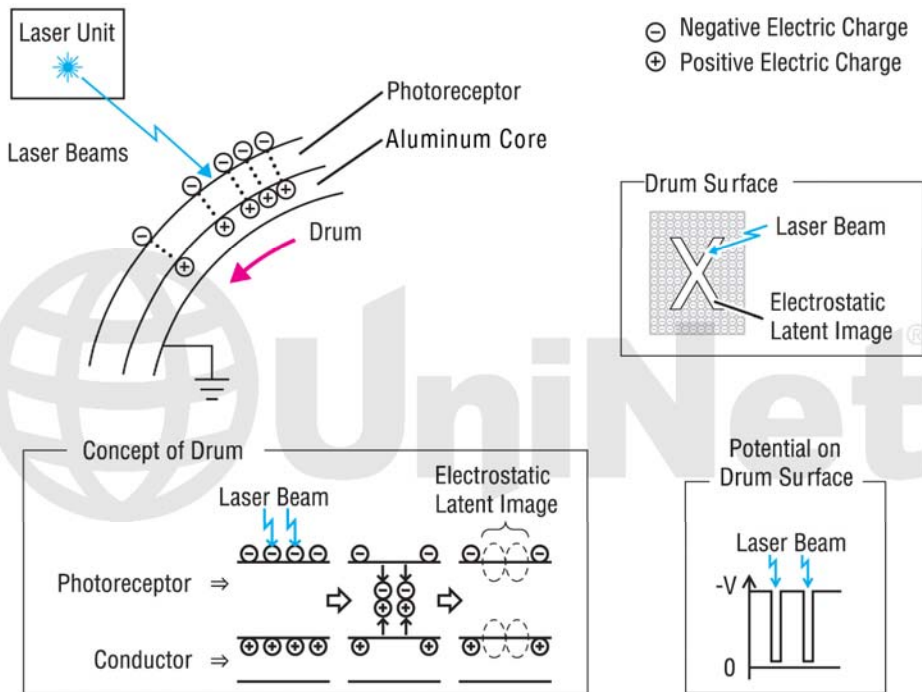
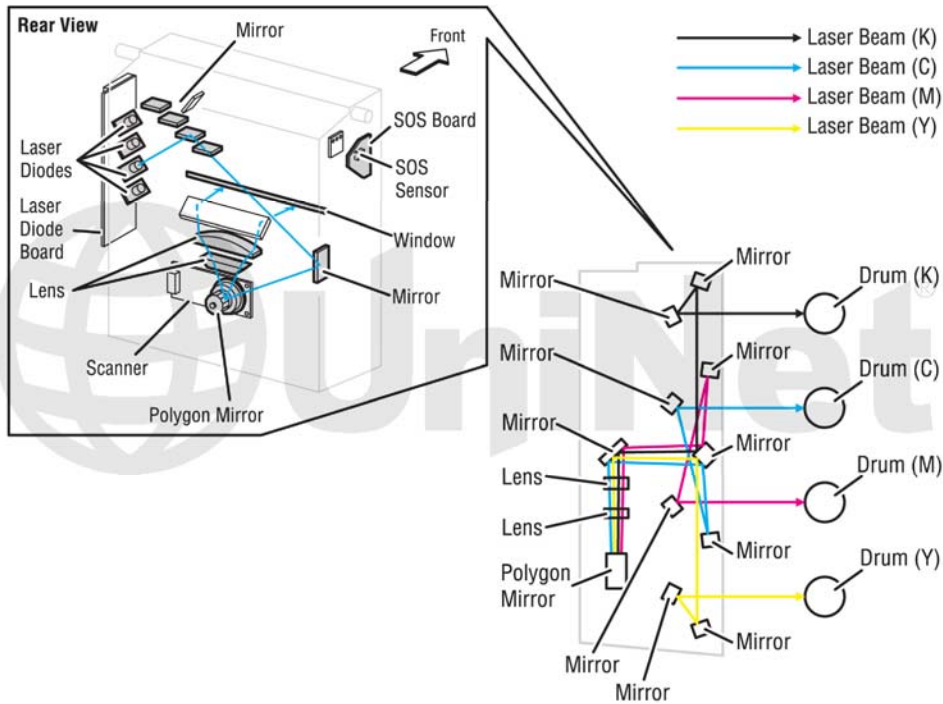

In the **second** stage, each color's laser beam is fired onto a set of fixed mirrors and then to the rotating mirror (called the scanner). As the mirror rotates, the beams are reflected into a set of focusing lenses. The beams then strike the drums surface, reducing the negative charge and leaving a latent electrostatic image on the drum. The areas where the lasers did not strike the drum will retain the higher negative charge.

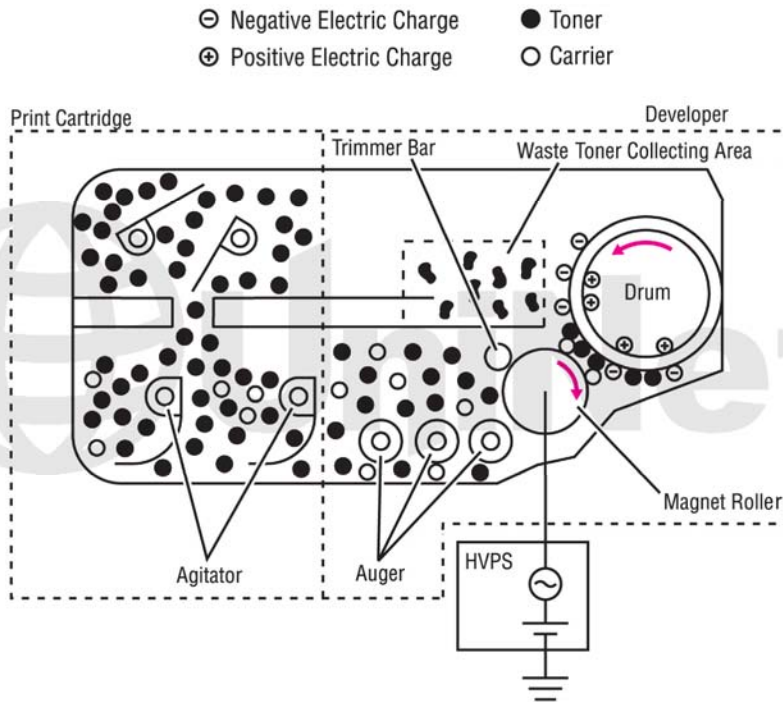

The **third** or developing stage is where the toner is developed on the drum by the developing section (or supply chamber), which contains the toner and developer particles. The toner is moved from the hoppers by a series of agitators into the developer section where the augers and magnetic roller are located. The toner is brought out to the drum by the magnetic roller. The toner is also held onto and attracted to the magnetic roller by a negative DC bias voltage. This voltage is controlled by the printer's intensity setting and causes either more or less toner to be attracted by the developer roller. This in turn will either increase or decrease the print density. The amount of toner on the magnetic roller is controlled by the doctor blade, which uses pressure to keep the amount of toner on the roller constant.

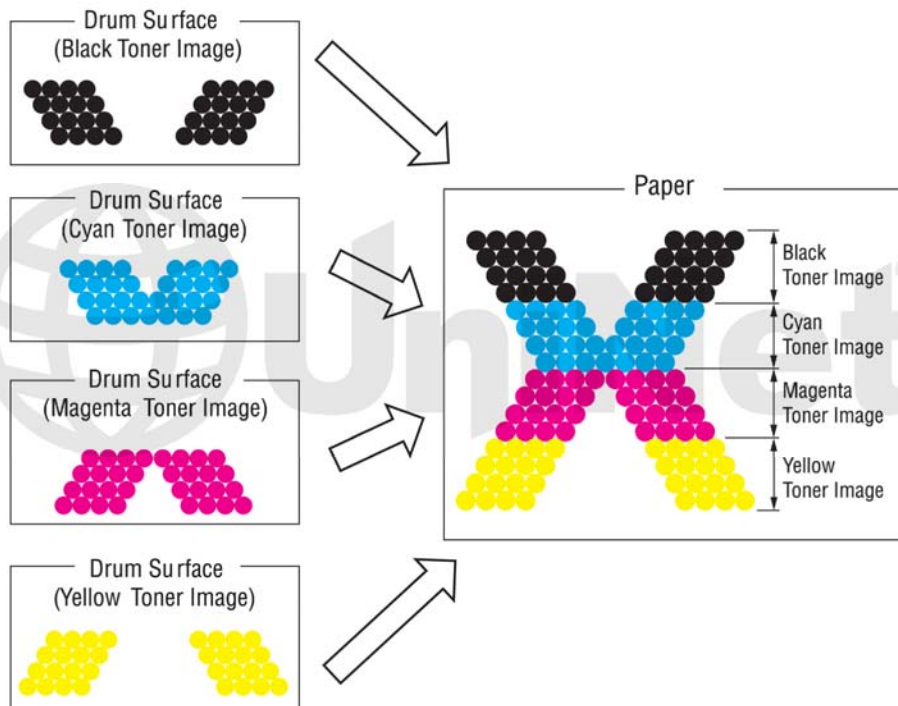

As the laser exposed areas of the OPC drum approach the developer roller, the toner particles are attracted to the drum's surface due to the opposite voltage potentials of the toner, and laser exposed areas of the OPC drum.

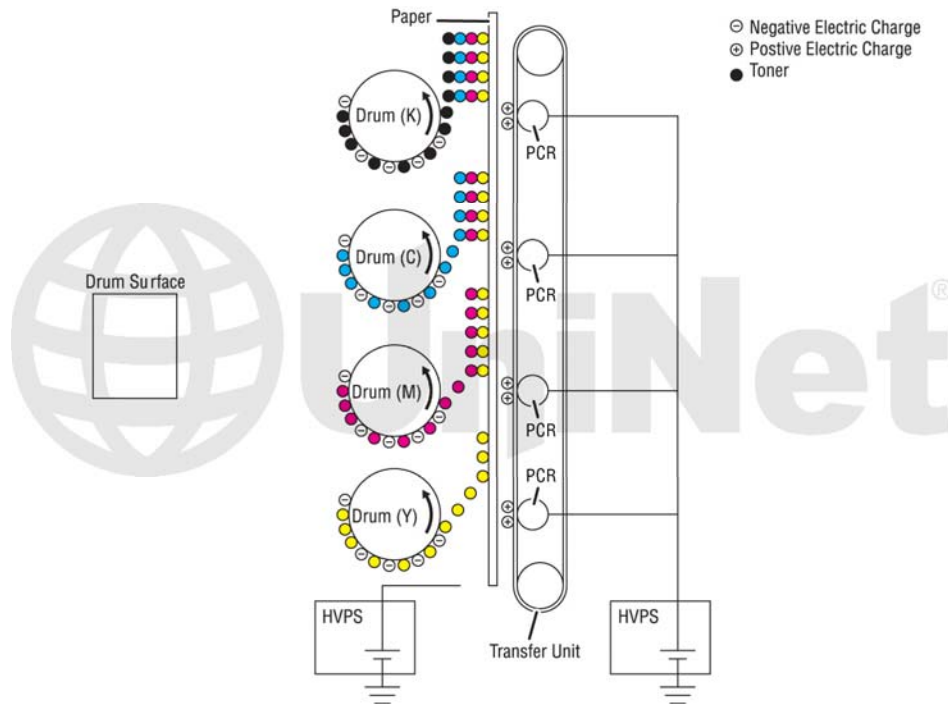

The **fourth** stage is the transfer stage. This is where there are some large differences from monochrome printers and also from other color lasers. In the primary transfer stage, the transfer rollers which are located directly opposite each OPC drum places a positive DC bias charge on the back of the transfer belt. Each toner cartridge has a separate transfer charge roller. As the paper moves through the machine, the image is transferred from the drum directly to the paper. This process is repeated for each color cartridge in the following order: yellow, magenta, cyan, and black.

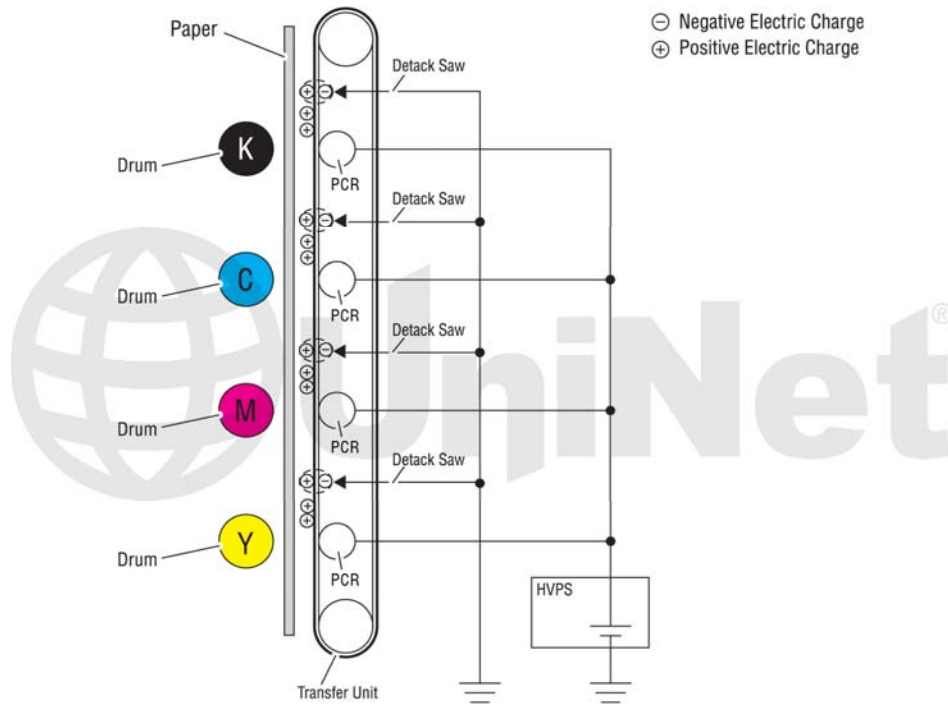

The paper separates from the transfer belt as the belt turns back down to start the process again. The static charge on the back of the paper is decreased with static charge eliminator. This helps stabilize the paper feed, and also prevents toner flares (spots) under low temperature and low humidity conditions.

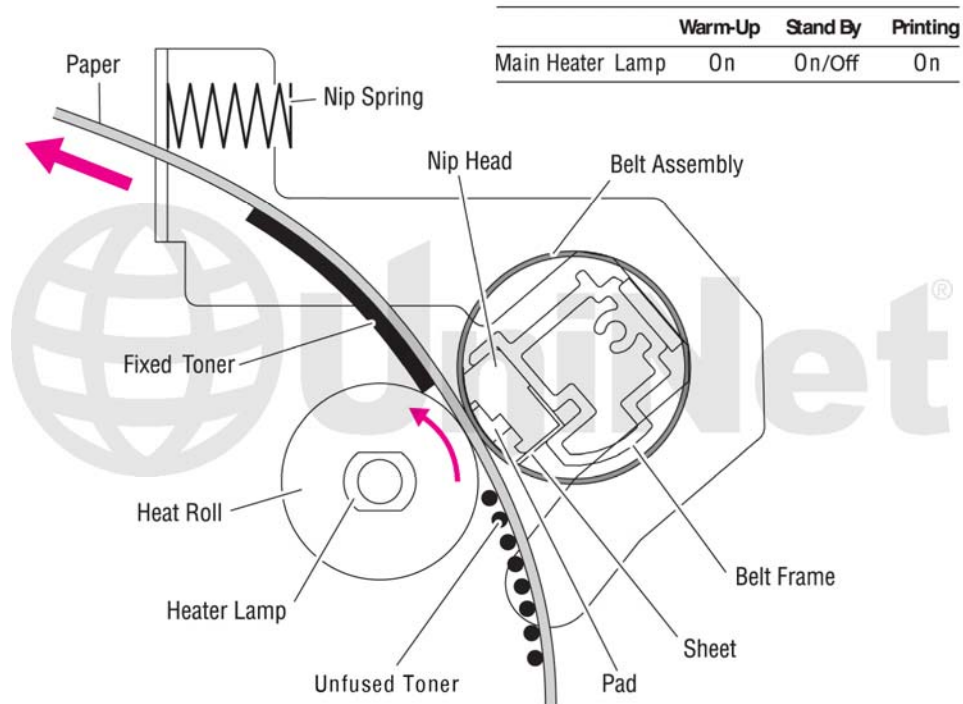

In the **fifth** stage, the image is then fused onto the paper by the fuser assembly. The fuser assembly is comprised of the upper heating assembly and lower pressure roller. The lower pressure roller presses the page up into the upper heating assembly which then melts the toner into the paper. This heating assembly is based on older technology. It uses a heat lamp and a pressure roller assembly and not the ceramic heaters that many machines now use.

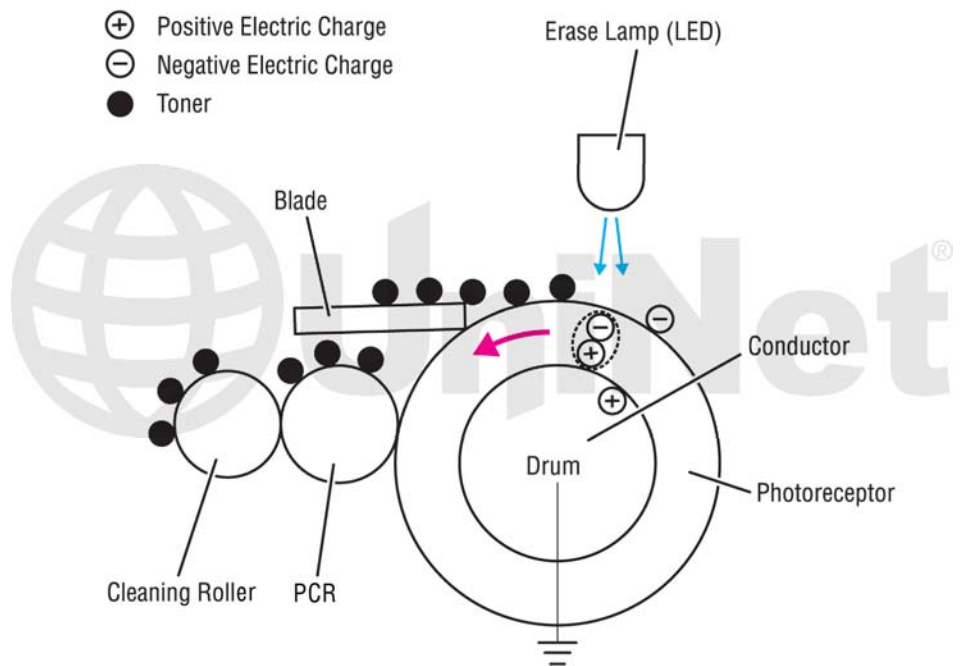

**OPC drum cleaning:** The drum is cleaned after the image is transferred to the paper by the wiper blade. This part is fairly standard; the wiper blade scrapes the toner off the drum, and the recovery blade guides it into the waste chamber. These machines also have an erase lamp to remove any residual charges from the drum and allow the wiper blade to clean better.

Cartridge troubleshooting will be covered at the end of this article.

**SUPPLIES REQUIRED**

1. Dedicated color toner (high yield or low yield) for use in Lexmark X560
2. Dedicated color developer (high yield or low yield) for use in Lexmark X560
3. Replacement chip (high yield or low yield)
4. Dedicated OPC drum
5. Drum cover
6. Toner seal
7. Developer seal
8. Fill hole seal

**TOOLS REQUIRED**

1. Phillips head screwdriver
2. Small common screwdriver
3. Jewelers screwdriver set
4. Spring hook
5. Vacuum approved for toner



1. Remove the two springs from either side to the cartridge.

The contact side is easier to remove if the cartridge is upside down.





2. Remove the screw from the black end cap on the contact side.



3. Remove the screw from the white end cap.



4. Remove the white end cap by prying up on the tab as shown.

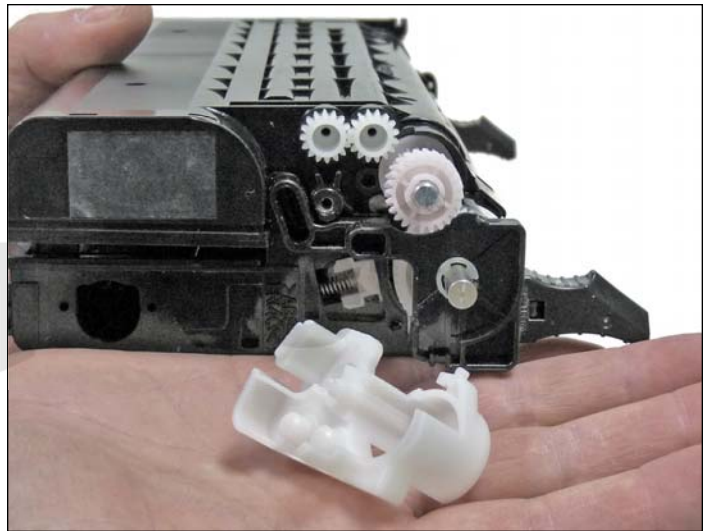

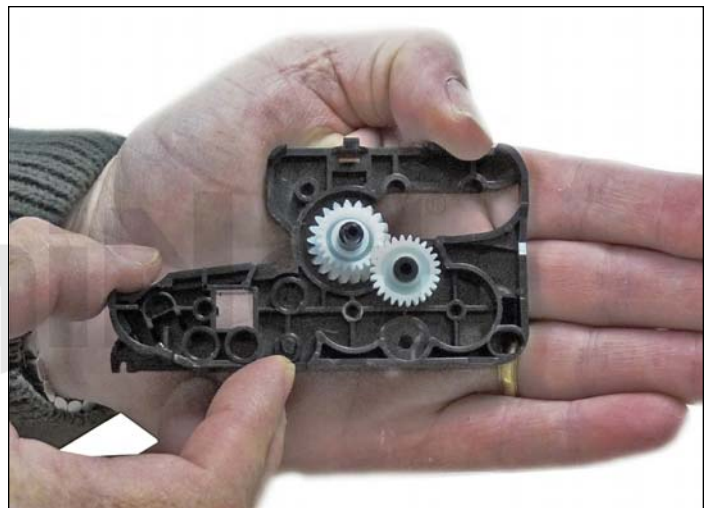
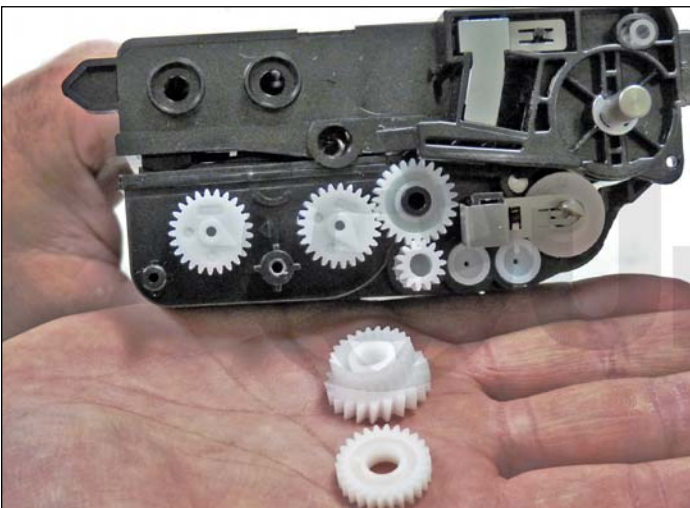
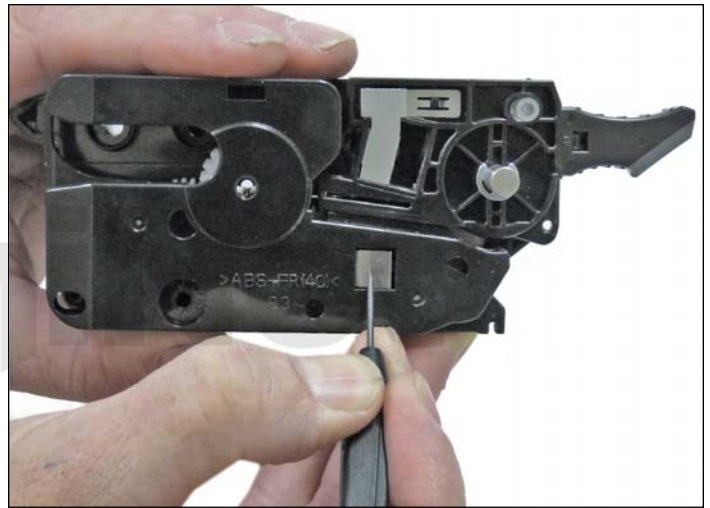

5. Remove the black and cap by prying up the tab to release it, press down on the lower contact plate and pry up around the bottom edges. The end cap will come free. It's important to press the lower contact plate down so it does not become damaged. Two white gears will come off with the end cap. It is best to store them on their respective shafts as shown.

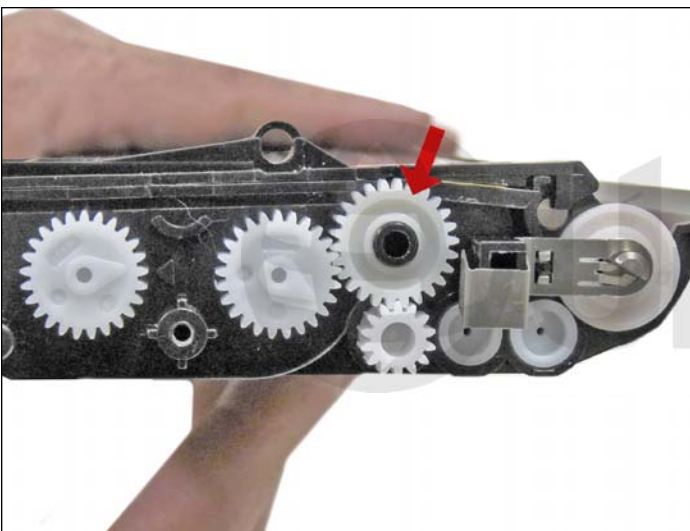

6. Remove the single gear with the black axle as shown. Do not remove the three remaining gears as they are attached inside the hopper.



7. Separate the two halves.

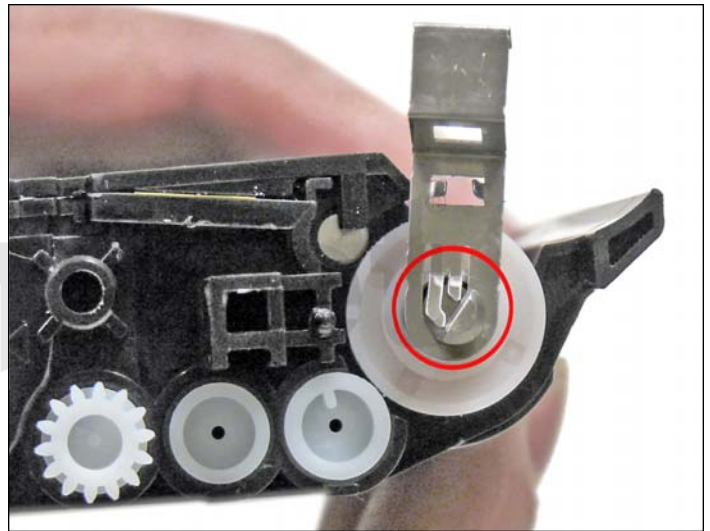
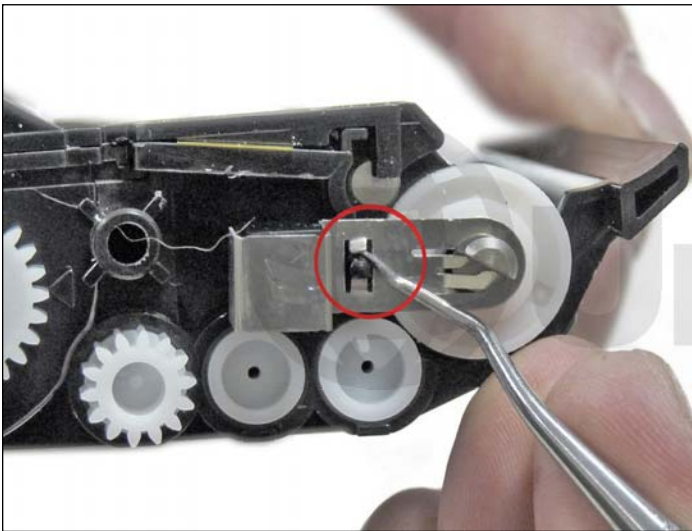

8. On the toner hopper, remove the magnetic roller clip by lifting up the two small tabs from the plastic shaft.

Turn the contact towards the flat side of the magnetic roller shaft and remove.



9. Remove the large magenta roller drive gear.



10. Remove the front auger drive gear so the bearing can be removed.

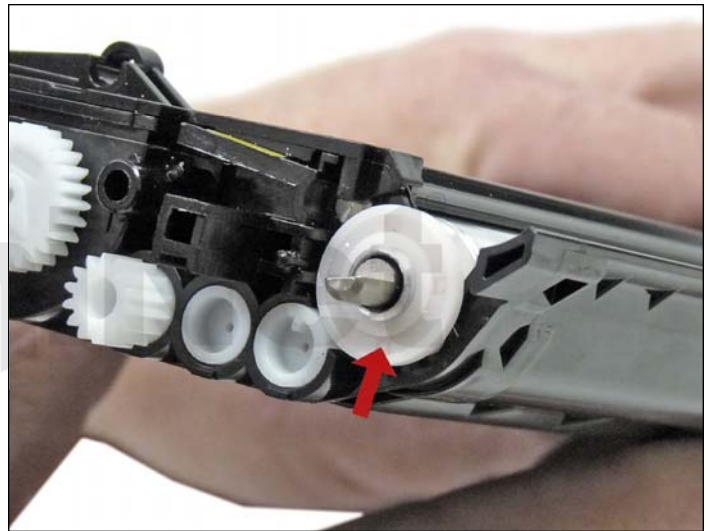
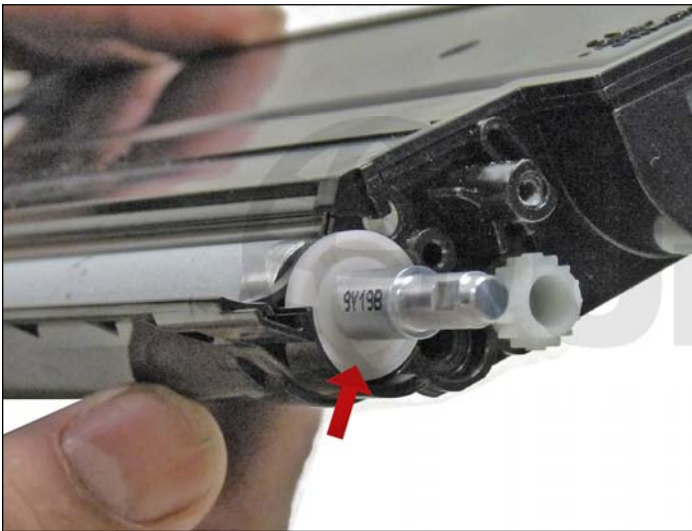

11. Remove the round bearings from both sides of the magnetic roller.

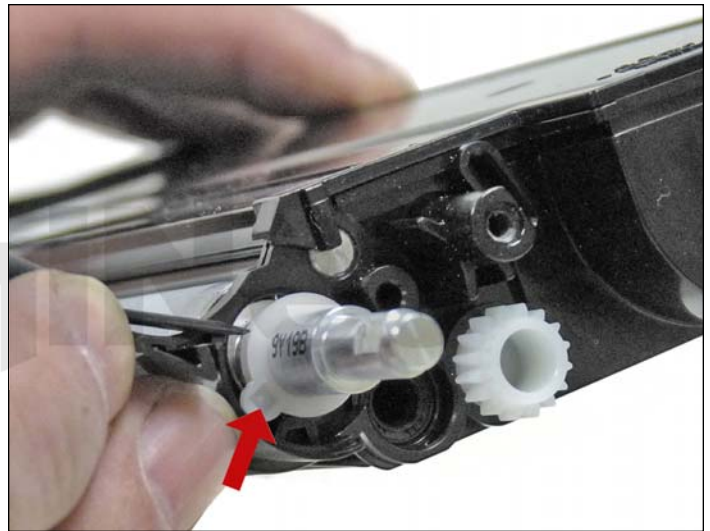
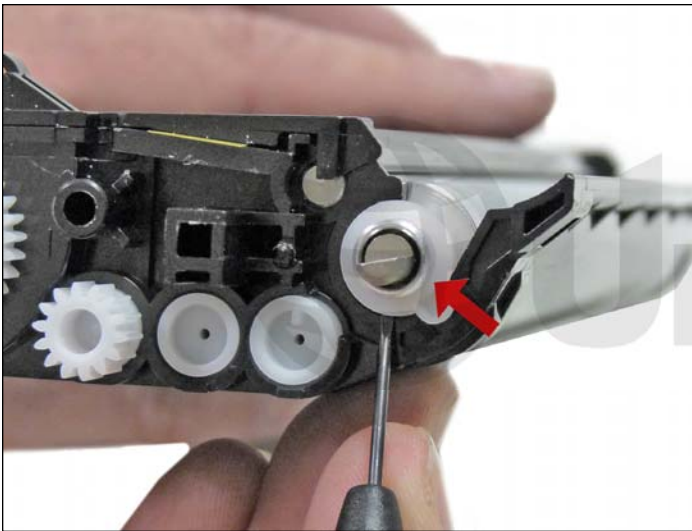

12. Remove the magnetic roller support bearings from both sides.



13. Lift the magnetic roller out by lifting it up from the short shaft side.

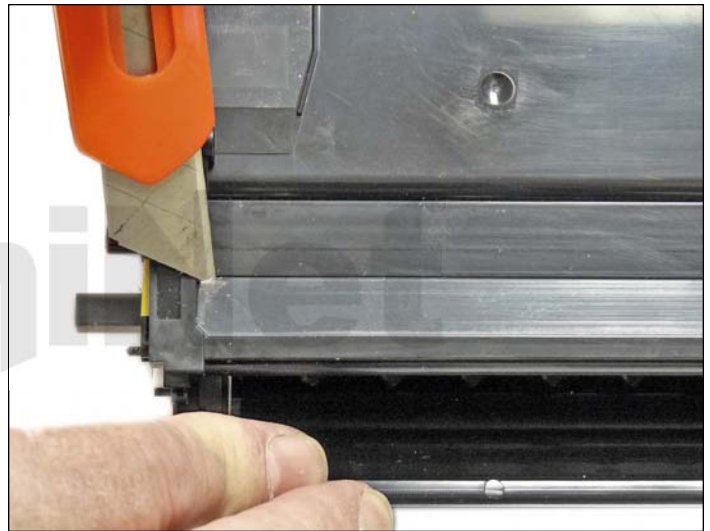
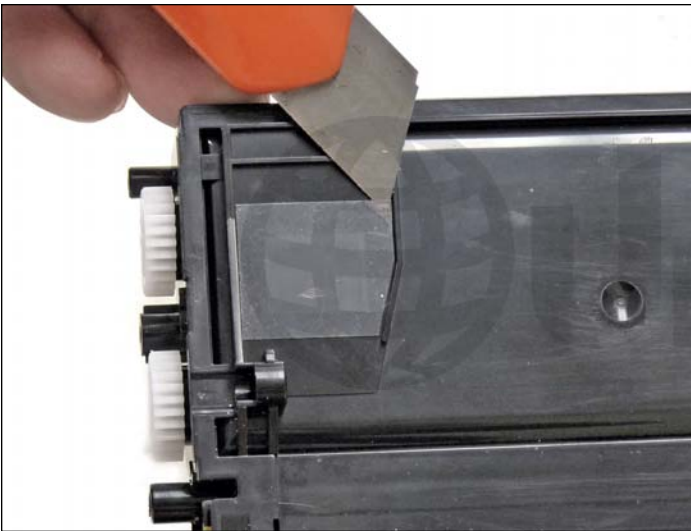

14. Remove the toner hopper sealing strip, and the developer chamber sealing strip.

New seals are now available so there is no need to re-use them.

Clean out all remaining toner and developer.



15. Install the magnetic roller long shaft side first.

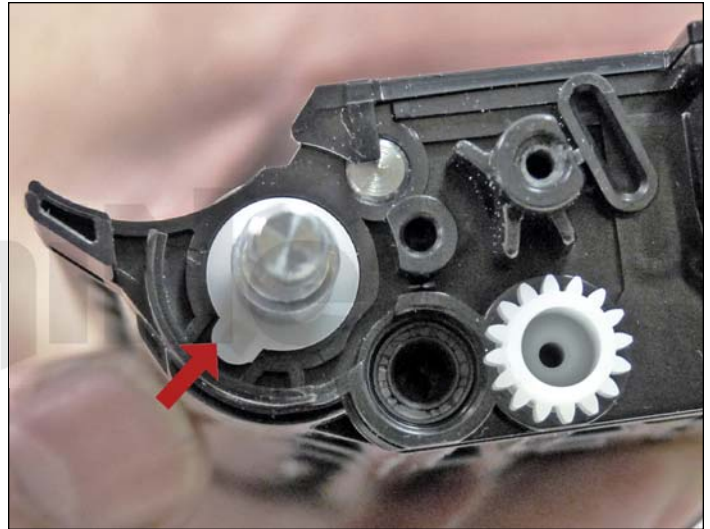
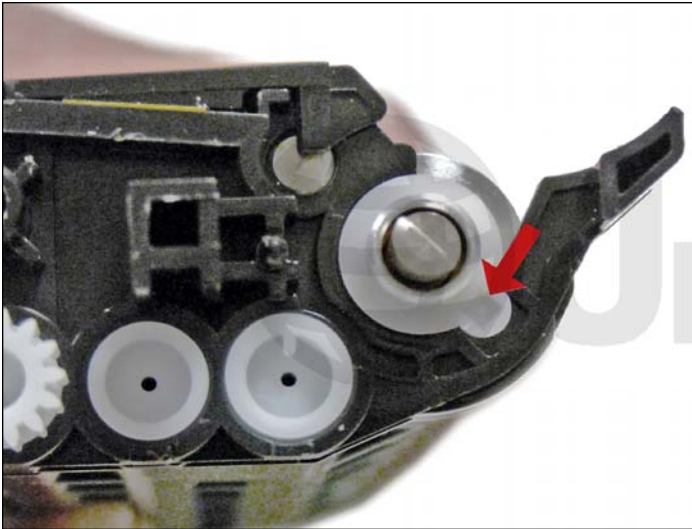

16. Install the support bearings on both sides of the cartridge.

Make sure the tab on the bushing is set in its slot as shown.

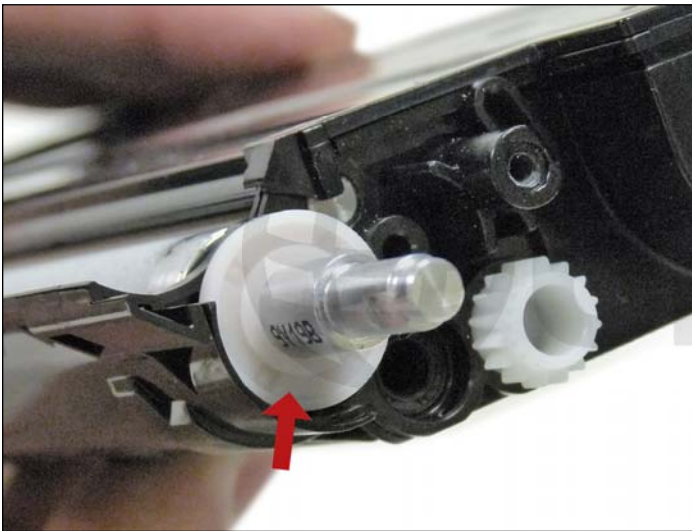

17. Install the round bearings on both sides of the magnetic roller.



18. Install the front auger gear. Make sure it is installed correctly. It must mesh properly with the auger or print voids will occur.

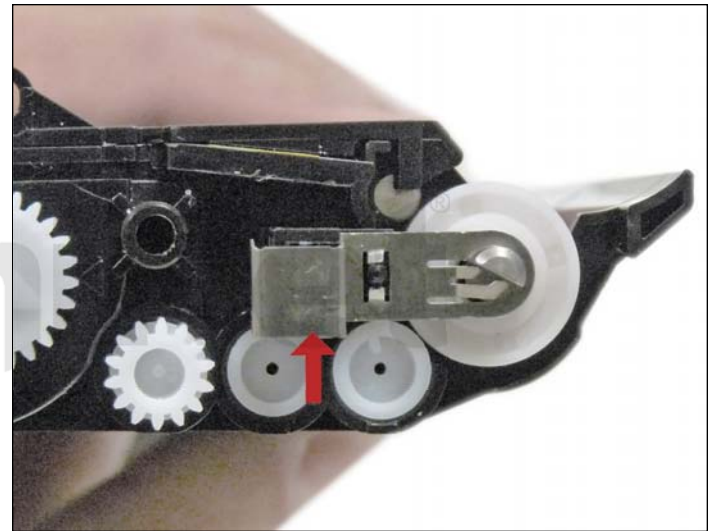
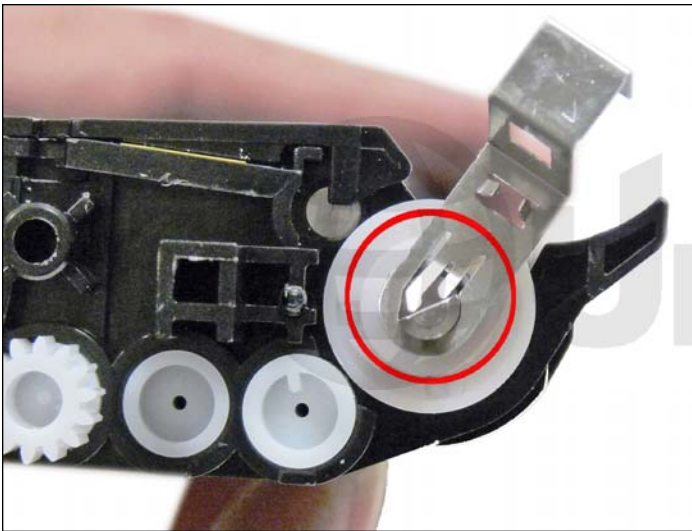

19. Install the magnetic roller contact.

Set the fingers so they are contacting the flat side of the shaft and turn the whole assembly until it fits in place.



20. Place a piece of paper across the developer chamber opening so it blocks the magnetic roller. Fill the chamber with the dedicated developer. Remove the paper. The paper makes it simpler to fill the chamber by blocking off the magnetic roller.

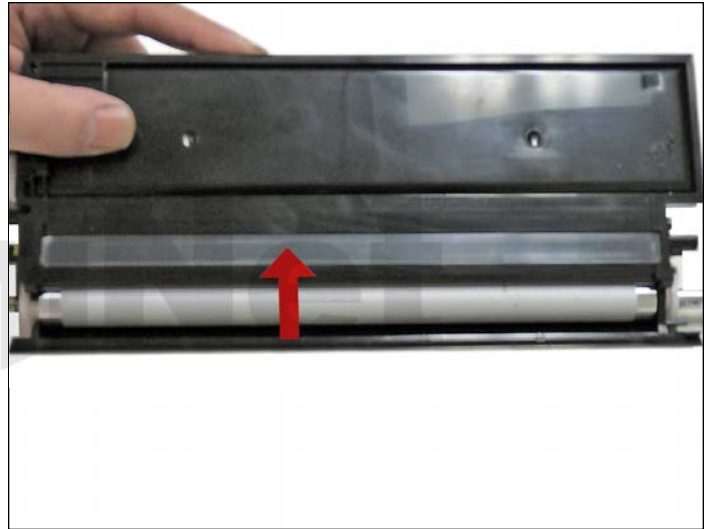

21. Clean the edge of the developer chamber opening with a cotton swab dipped in alcohol. Install the new seal.



22. For low yield cartridges, fill the toner chamber now. Clean the edge of the chamber with alcohol and install the new seal. High yield cartridges have two chambers so it is easier for them to be filled later. Both chambers should be filled at the same time in order to get the correct amount in each (they will be filled at the end of these instructions in step 45).

**NOTE:** Do NOT mix the developer with the toner. They must be separate inside the cartridge for the system to work correctly. Place the toner chamber aside.

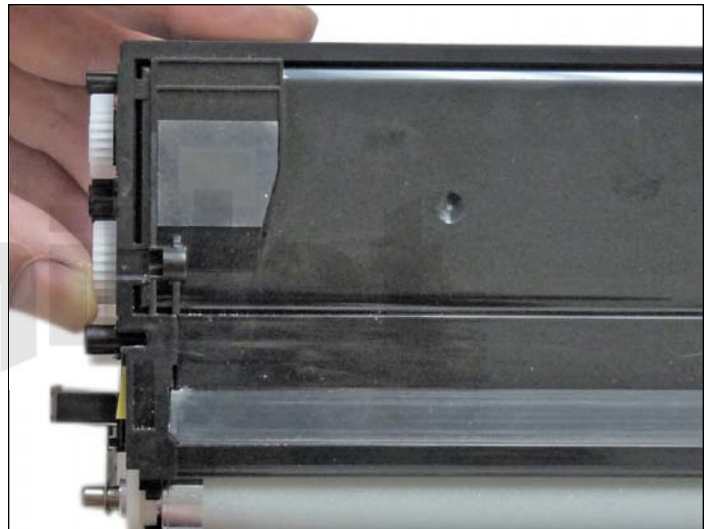





23. On the drum chamber, remove the “E” ring from the contact or hub side of the drum.



24. Pull the axle out from the gear side of the drum so that the inner drum ground contacts are not damaged.



25. Remove the drum.



26. Remove the PCR and clean with a lint free cloth.



27. Remove the PCR cleaning roller.

Vacuum or blow any toner from the roller.



28. Remove the two PCR and PCR cleaning roller holders. Carefully pry them up from the sides. Clean them with a cotton swab and alcohol.



29. High yield cartridges have a seal and set of gears for the additional augers. Remove the seal and clean out any remaining toner.

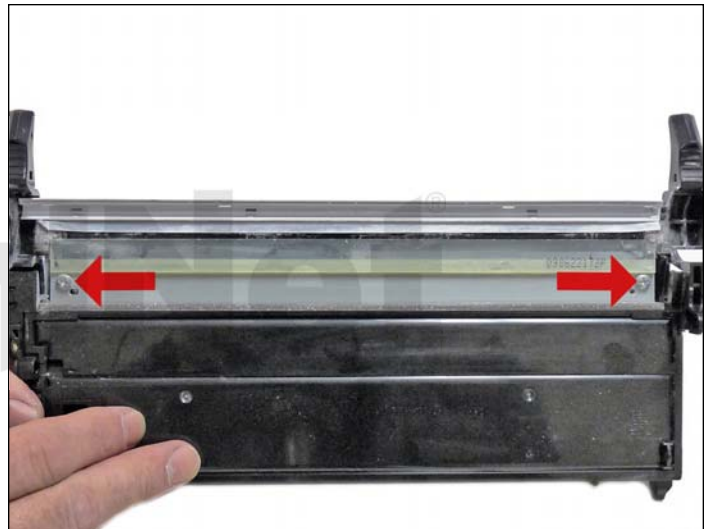

30. Remove the two screws and the wiper blade.

Clean out any toner from the waste chamber.



31. Coat the wiper blade with your preferred lubricant and install. Install the two screws.



32. Clean the PCR holders and PCR cleaning roller holders with a cotton swab and alcohol.

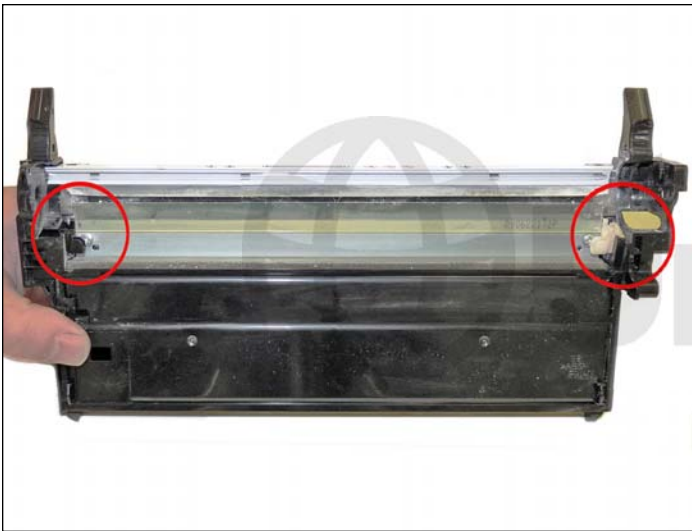

33. Install the cleaned PCR and PCR cleaning roller holders.

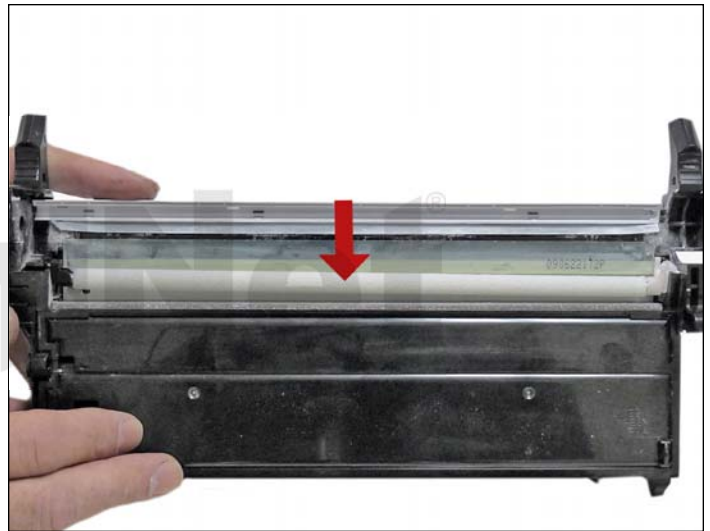

34. Install the cleaned PCR cleaning roller.



35. Install the cleaned PCR. Place a small amount of new conductive grease on the black holder side.



36. Install the drum.

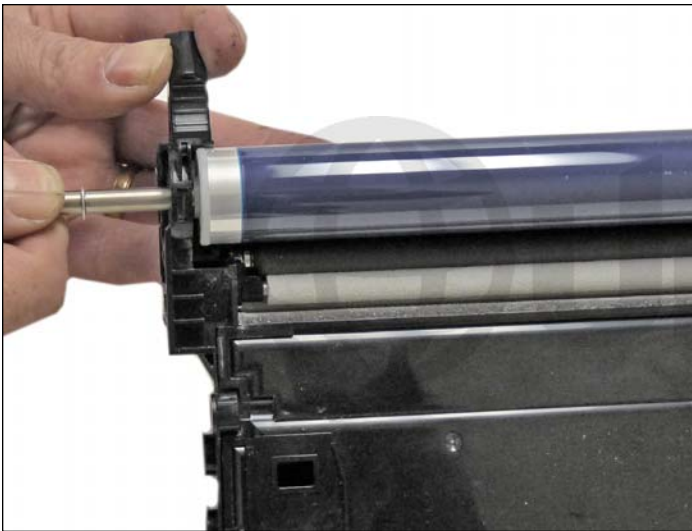

37. Install the drum axle from the hub side.



38. Install the E ring.

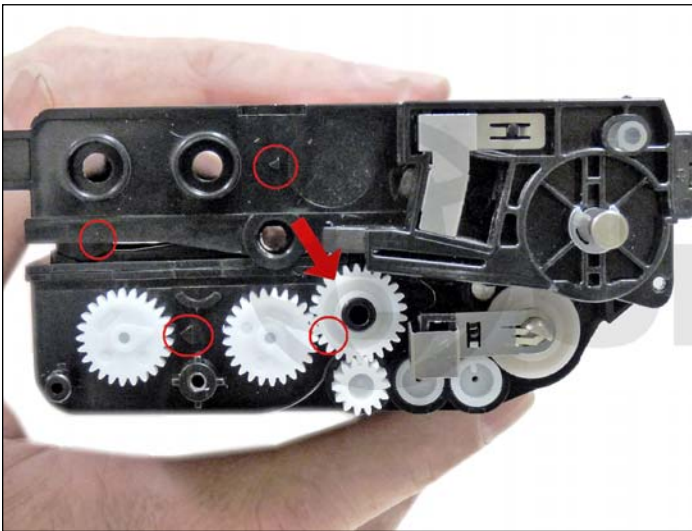

39. On the toner hopper, install the white auger gear as shown. At this point the remaining gears must also be set properly. If the cartridge is a high yield, the top two gears must point to the arrows on the cartridge as shown. For all cartridges on the lower half, the gears must be pointing to the arrow and gear as shown.

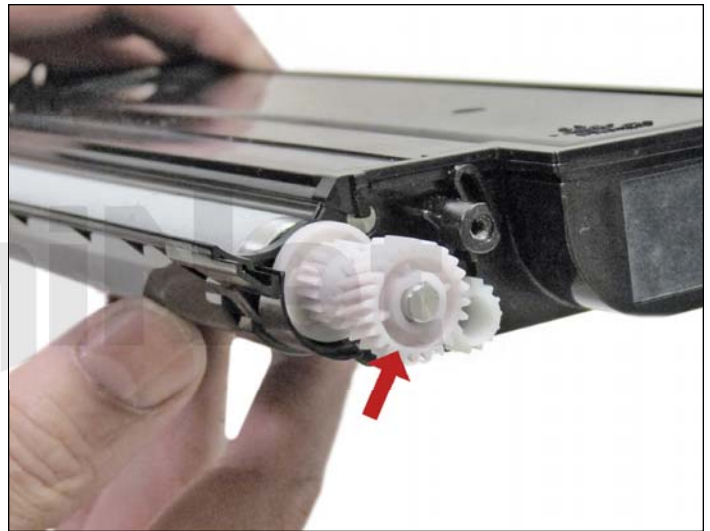

40. Install the developer roller drive gear.



41. Place the two halves together.



42. With the two gears placed on the black end cap, install the end cap.

Make sure the tab locks in place.

Install the screw.

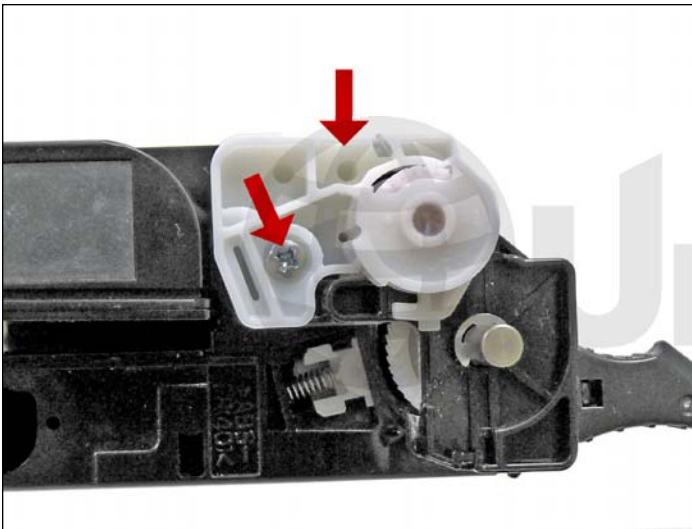

43. Install the white end cap and screw.

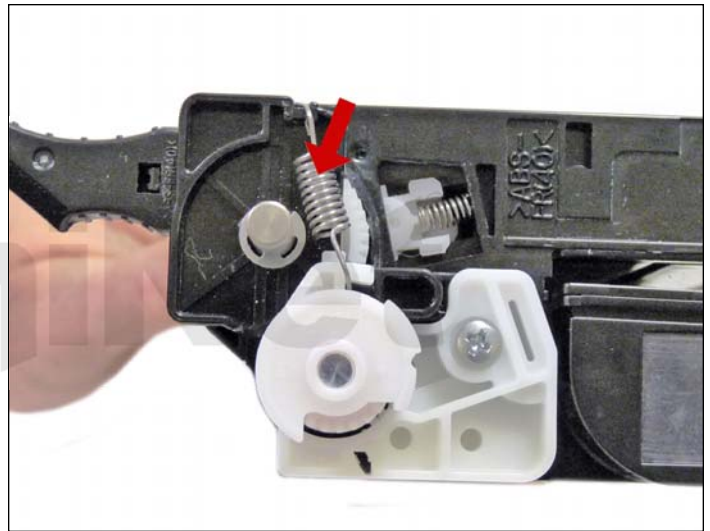
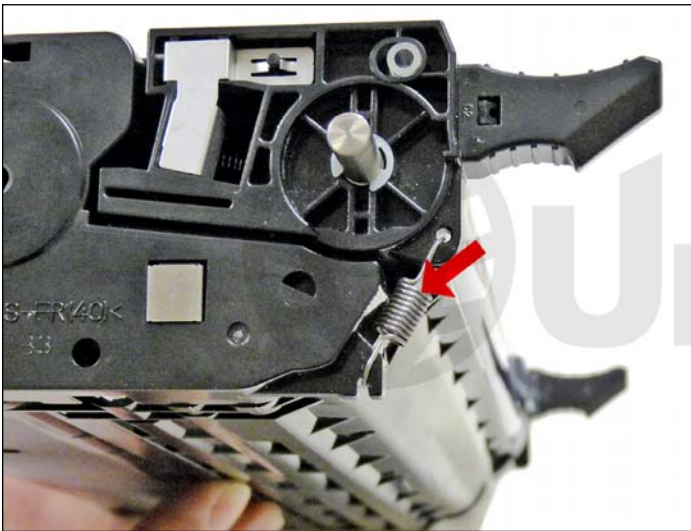

44. Install the springs on both sides of the cartridge.

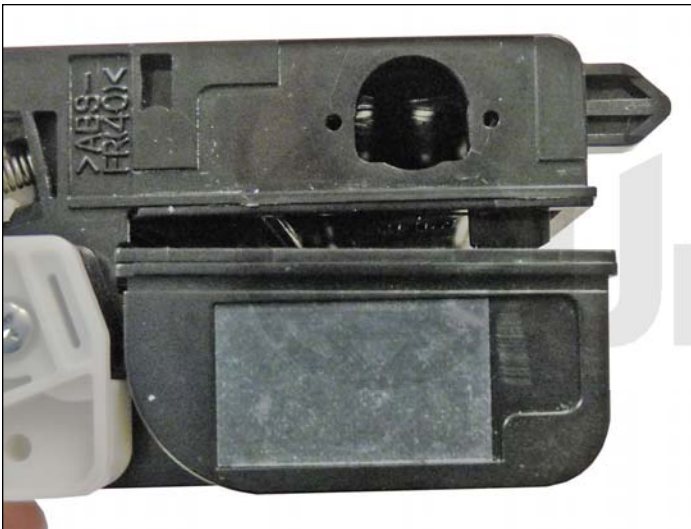

45. If you have a high yield cartridge, fill the upper (drum unit) and lower (toner) hoppers now. We have found it best to fill the upper hopper with 1/4 of the bottle and the rest in the lower hopper.

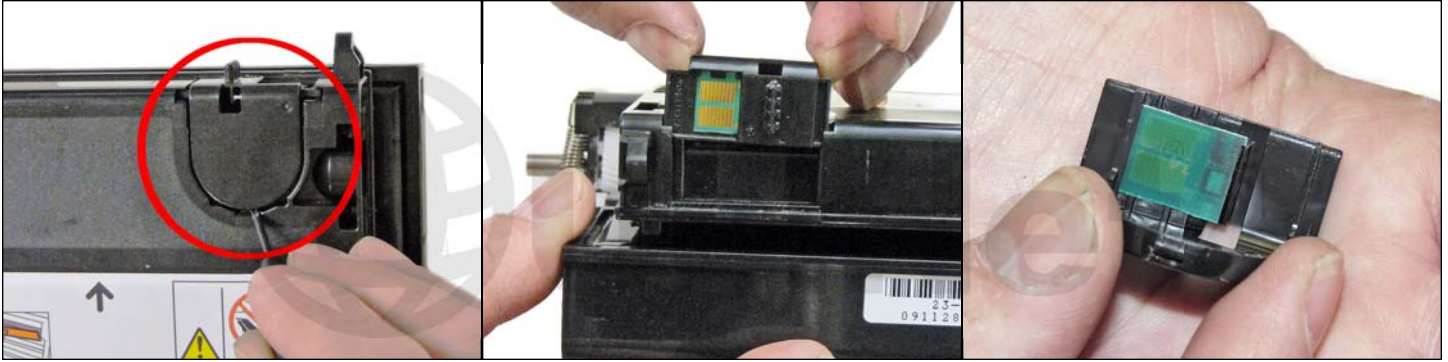

46. Remove the old chip by prying out and lifting up on the black plastic holder.

Remove the old chip from the holder and slide the new chip into the rails.

Make sure it snaps into place.



47. Install the chip holder assembly onto the hopper.



48. Install the drum cover.



**REPETITIVE DEFECT CHART**

<b>OPC drum:</b>	<b>75.4 mm</b>
<b>PCR:</b>	<b>28.3 mm</b>
<b>PCR cleaning roller:</b>	<b>25.1 mm</b>
<b>Black and color magnetic roller sleeve:</b>	<b>27.9 mm</b>
<b>1st primary transfer roller:</b>	<b>31.4 mm</b>
<b>Drive roller transfer unit:</b>	<b>56.9 mm</b>
<b>Upper fuser roller:</b>	<b>82.7 mm</b>
<b>Fuser drive belt:</b>	<b>94.2 mm</b>
<b>Pinch roller fuser assembly:</b>	<b>18.8 mm</b>
<b>Exit roller fuser assembly:</b>	<b>43.1 mm</b>
<b>Exit pinch roller fuser assembly:</b>	<b>31.4 mm</b>